



SAH
Stahlwerk Annahütte

SAS Schalungstechnik - Katalog

SAS Formwork ties - catalogue

SAS SYSTEMS

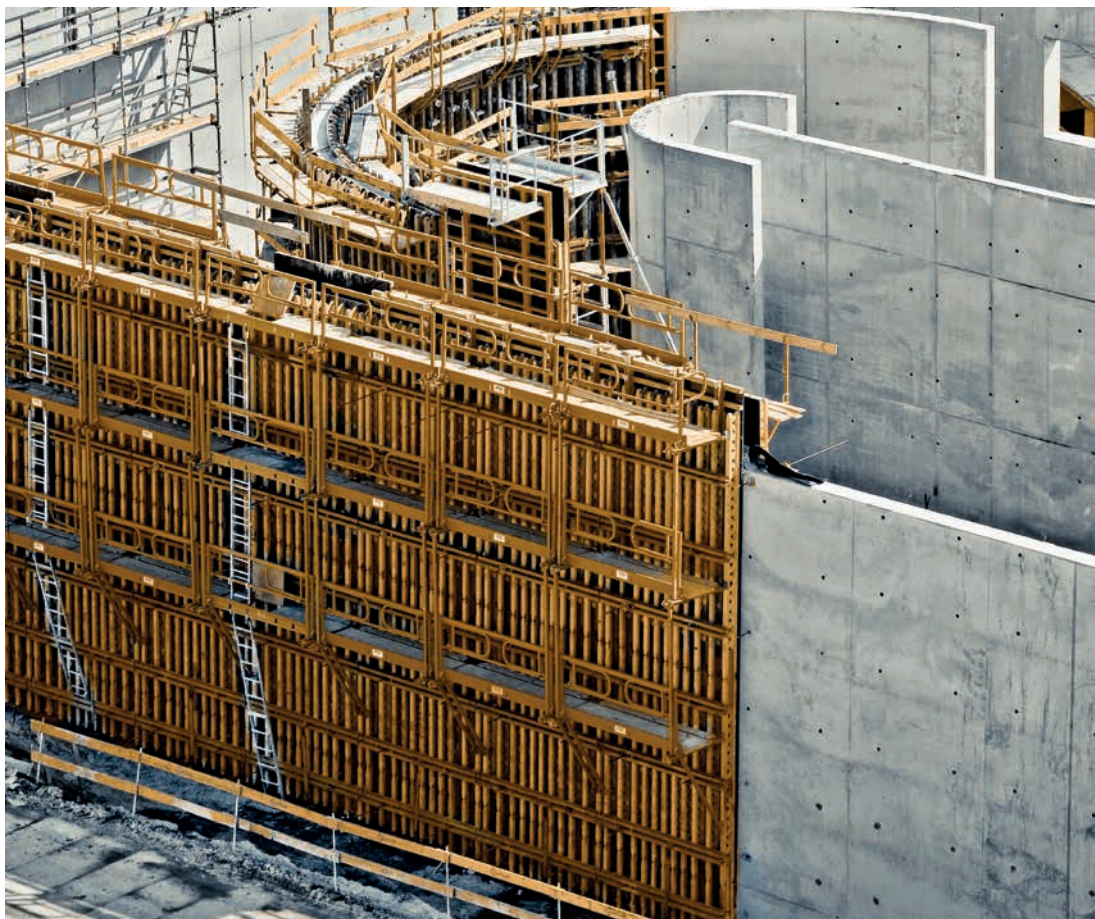

MAX AICHER
UNTERNEHMENSGRUPPE

Bezeichnung specification	Seite page			
	Ø12,5	Ø15	Ø20	Ø26,5
Anschweißflansch welding flange	—	9	—	—
Anschweißstück welding bolt	—	8	22	—
Beton-/Felsanker 2-schalig expansion shell 2-leaf	—	14	—	32
Beton-/Felsanker 3-schalig expansion shell 3-leaf	—	15	25	—
Bundmutter hexagonal nut with extension	—	9	—	—
Flanschmutter flange nut	4	10+11	23	—
Flügelmutter wing nut	—	11	23	31
Hakenanker hook anchor	—	6	21	28
Kalottenplatte dome plate	—	16	25	—
Kombiplatte combi plate	—	15-17	—	—
Kunststofffuß für Montageanker plastic coupler for fix anchor	—	14	—	—
Montageanker, groß fix anchor, large	—	14	24	32
Montageanker, klein fix anchor, small	—	13	—	—
Plattenanker plate anchor	—	15	25	—
Rundmutter round nut	—	9	—	—
Schalungsanker Typ E Tie Rod Type E	—	—	—	28
Schalungsanker Typ FA Tie Rod Type FA	—	5	20	28
Schalungsanker Typ FC Tie Rod Type FC	—	5	20	—
Schalungsanker Typ FS Tie Rod Type FS	4	5	20	—
Schlaufenanker loop anchor	—	6	21	28
Sechskantmutter hexagonal nut	—	9	22	30
Sechskantmutter, Volllast hexagonal nut	4	9	22	30
Stahlkonus steel cone	—	6	21	29
Stahl-Kunststoffkonus Typ MKK steel-plastic cone type MKK	—	7	22	29
Unterlagsplatte, geprägt washer stamped	—	13	—	—
Verbindungsmuffe, kurz, Sechskant coupler short, hexagonal	—	—	—	31
Verbindungsmuffe, sechskant coupler, hexagonal	4	10	23	31
Vollplatte, rechteckig plate rectangular	—	—	—	32
Vollplatte, quadratisch plate square	—	—	24	31+32
Vorlaufkonus Typ 30 cone type 30	—	8	—	—
Vorlaufkonus Typ 30/M24 / Typ 40/M36 cone type 30/M24 / type 40/M36	—	7	—	29
Wassersperre mit Absatz waterstop with landing	—	12	23	—
Wassersperre mit Innenaufnahme waterstop	—	11	—	—
Wassersperre / Stab waterstop / tie rod	—	12	24	31
Wellenanker wave anchor	—	5	21	28

Die Gewichtsangaben sind Mittelwerte. Die tatsächlichen Gewichte können aufgrund von Fertigungstoleranzen abweichen.
Weight specifications are average values. The actual values may deviate due to fabrication tolerances.

Streckgrenze/Zugfestigkeit yield stress/ultimate stress	Nenn-Ø nom.-Ø	Tragkraft ¹ working load	Strecklast yield load	Bruchlast ultimate load	Fläche cross section area		Gewicht weight	Dehnung elongation	
					[mm ²]	[m/to]		A _{gt} [%]	A ₁₀ [%]
SAS 900 / 1100 FA grade 160 FA					warmgewalzt, schweißbar hot rolled, weldable				
	15	90	159	195	177	694,4	1,44	3	7
SAS 900 / 1100 Typ FA	20	160	283	345	314	390,6	2,56		
	26,5	280	495	606	551	223,2	4,48	2	7

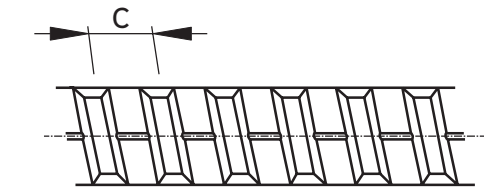

Längsnuten zwischen den Rippen | longitudinal slots between ribs

SAS 900 / 1050 FC grade 150 FC					warmgewalzt hot rolled				
	15	90	159	186	177	694,4	1,44	3	7
SAS 900 / 1050 Typ FC	20	160	283	330	314	390,6	2,56		
SAS 950 / 1050 E grade 150	26,5	300	525	580	551	223,2	4,48	5	7

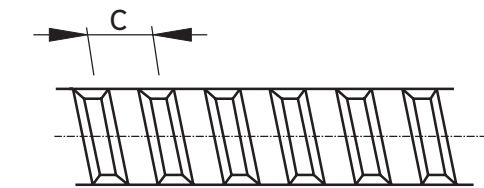

SAS 750 / 875 FS grade 120 FS					kaltgerollt, schweißbar cold rolled, weldable				
	12,5	50	90	120	132,5	961,5	1,04		
SAS 750 / 875 FS	15	80	142	165	189	675,7	1,48	2	5,5
	20	140	245	285	326	390,6	2,56		

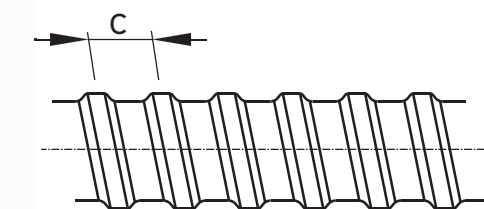

¹Geprüft nach DIN 18216
Proof acc. DIN 18216

Ø12.5

Ø 12,5 mm

SAS Schalungsanker Typ FS gerollt, schweißbar
SAS Tie Rod Type FS cold rolled, weldable

schwarz | black 12FS...
verzinkt | galvanized 12FS...G

$a_1 = 12,5\text{mm}$
 $a_2 = 14\text{mm}$
L = variabel bis max. 6m | variable up to max. 6m

Gewicht | weight 1,04 kg/m
Tragkraft | working load 50 kN
Werkstoff | material SAS 750/875

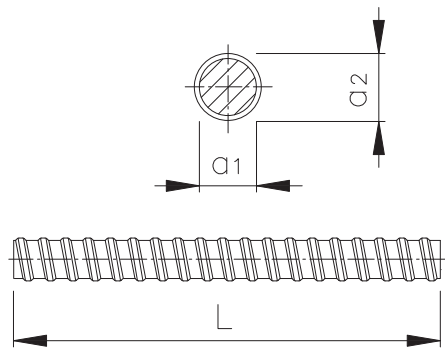

Sechskantmutter Volllast | hexagonal nut

schwarz | black 12F 22 050
verzinkt | galvanized 12F 22 050 G

L = 50mm
SW = 24mm
Gewicht | weight 0,13kg
Tragkraft | working load 50kN
Werkstoff | material S355J2

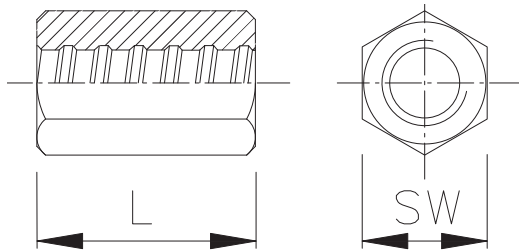

Verbindungs- mufte Sechskant | coupler hexagonal

schwarz | black 12F 28 090
verzinkt | galvanized 12F 28 090 G

L = 90mm
SW = 24mm
Gewicht | weight 0,24kg
Tragkraft | working load 50kN
Werkstoff | material S355J2

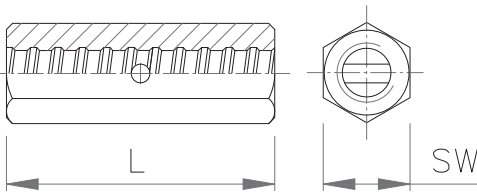

Flanschmutter | flange nut

verzinkt | galvanized 12F 31 070 G

$a = 110\text{mm}$
 $b = \text{Ø}70\text{mm}$
 $h = 50\text{mm}$
SW = 24mm
Gurtungsabstand | girder spacing 35mm
Gewicht | weight 0,43kg
Tragkraft | working load 50kN
Werkstoff | material EN-GJMW-400-5 / EN-GJS-500-7

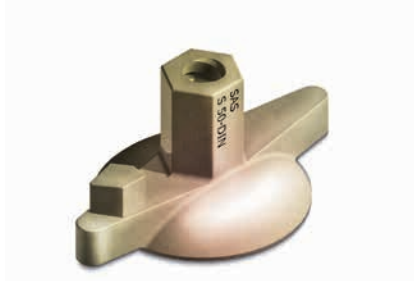
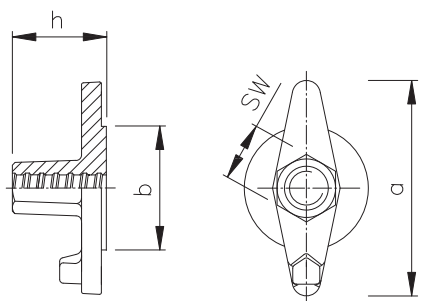

Ø15.0

Ø 15,0 mm

SAS Schalungsanker Typ FA¹ gewalzt, schweißbar
SAS Tie Rod Type FA hot rolled, weldable

schwarz | black 15FA...
verzinkt | galvanized 15FA...G

$a_1 = 15\text{mm}$
 $a_2 = 17\text{mm}$
L = variabel bis max. 15m | variable up to max. 15m
L = verzinkt max. 6m | galvanized max. 6m

Gewicht | weight 1,44 kg/m
Tragkraft | working load 90kN
Werkstoff | material SAS 900 / 1100

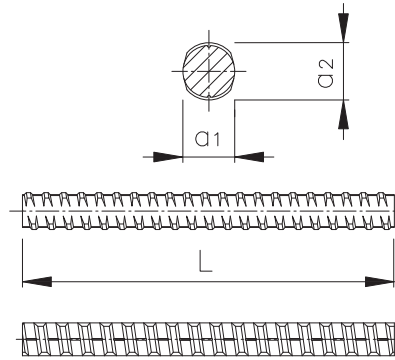

SAS Schalungsanker Typ FC gewalzt
SAS Tie Rod Type FC hot rolled

schwarz | black 15FC
verzinkt | galvanized 15FC...G

$a_1 = 15\text{mm}$
 $a_2 = 17\text{mm}$
L = variabel bis max. 15m | variable up to max. 15m
L = verzinkt max. 6m | galvanized max. 6m

Gewicht | weight 1,44 kg/m
Tragkraft | working load 90kN
Werkstoff | material SAS 900/1050

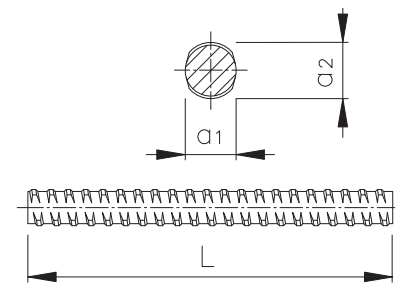

SAS Schalungsanker Typ FS gerollt, schweißbar
SAS Tie Rod Type FS cold rolled, weldable

schwarz | black 15FS...
verzinkt | galvanized 15FS...G

$a_1 = 15\text{mm}$
 $a_2 = 17\text{mm}$
L = variabel bis max. 6m | variable up to max. 6m

Gewicht | weight 1,48 kg/m
Tragkraft | working load 80kN
Werkstoff | material SAS 750 / 875

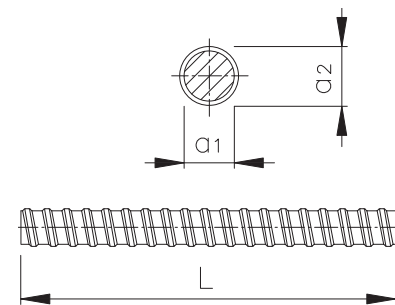

Wellenanker | wave anchor

Typ FA 15FA 66 550 W
Typ FA 15FA 66 670 W

L = 550mm
L = 670mm

Gewicht | weight 0,79kg
Gewicht | weight 0,96kg
Betongüte | concrete strength $\geq \text{C } 20/25$
 $\geq 25 \text{ MPa}$
Tragkraft | working load 90kN
Werkstoff | material SAS 900/1100

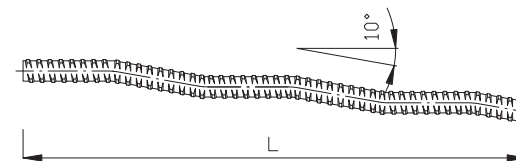

¹Kennzeichnung: Längsnuten zwischen Rippen
Marking: Longitudinal slots between ribs

Hakenanker | hook anchor

Typ FA 15FA 64 250 H
Typ FA 15FA 64 450 H

a = 120 mm
L = 250 mm

Gewicht | weight 0,72 kg

a = 120 mm
L = 450 mm

Gewicht | weight 1,00 kg

Betongüte | concrete strength $\geq C 20/25$
 $\geq 25 MPa$

Tragkraft | working load 90 kN

Werkstoff | material SAS 900/1100

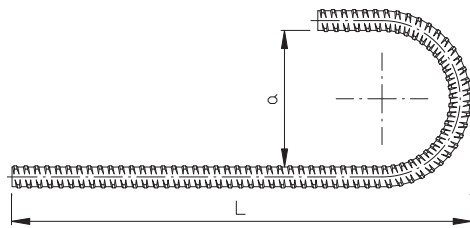

Schlaufenanker | loop anchor

Typ FA 15FA 65 550 S

a = 230 mm
L = 550 mm
L₁ = 360 mm
L₂ = 240 mm

Gewicht | weight 1,87 kg

Betongüte | concrete strength $\geq C 20/25$
 $\geq 25 MPa$

Tragkraft | working load 90 kN je Stabende | on each bar end

Werkstoff | material SAS 900/1100

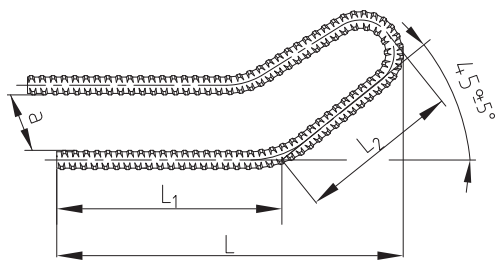

Stahlkonus Typ 30 | steel cone type 30

verzinkt | galvanized 15F 12 030

a = Ø80 mm
b = Ø30 mm
c = 55 mm
L = 102 mm
SW = 30 mm

Gewicht | weight 0,65 kg

Tragkraft | working load 90 kN

Werkstoff | material S355J2, C45+N

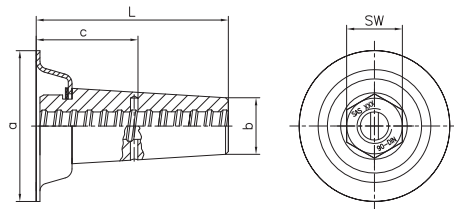

PE-Hülse für Stahlkonus Typ 30 | PE-sleeve for steel cone type 30

15F 12 030 K

a = Ø40 mm
b = Ø30 mm
L = 81 mm

Gewicht | weight 0,01 kg

Werkstoff | material PE

Zum einfachen Ausschrauben des Stahlkonus Typ 30. PE-Hülse wird vor der Montage auf den Konus gesteckt und verbleibt im Beton.
To ensure easy unscrewing of steel cone type 30. The PE-sleeve is put on the cone before installation and remains in the concrete.

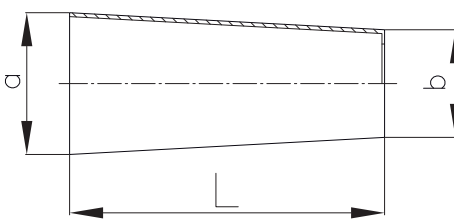

Stahl-Kunststoffkonus Typ MKK | steel-plastic cone type MKK

verzinkt | galvanized 15F 14 100

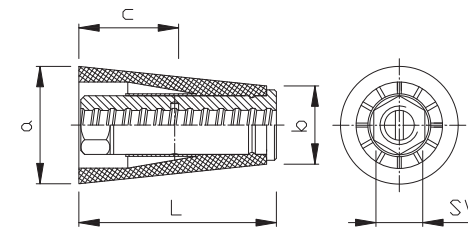

a = Ø60 mm
b = Ø40 mm
c = 50 mm
L = 101 mm
SW = 27 mm

Gewicht | weight 0,39 kg

Tragkraft | working load 90 kN

Werkstoff | material C45 + PP



Betonstopfen für Stahl-Kunststoffkonus Typ MKK
concrete plug for steel-plastic cone type MKK

15F 14 100 S

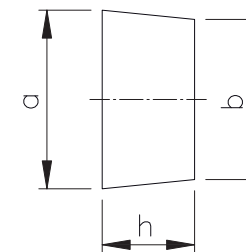

a = Ø59 mm
b = Ø53 mm
h = 30 mm

Gewicht | weight 0,15 kg

Werkstoff | material Beton | concrete

Zum Verschließen der Konuslöcher des Stahl-Kunststoffkonus.
For sealing of cone holes of the steel-plastic cone.



Vorlaufkonus Typ 30 / M24 | cone type 30 / M24

verzinkt | galvanized 15F 15 030

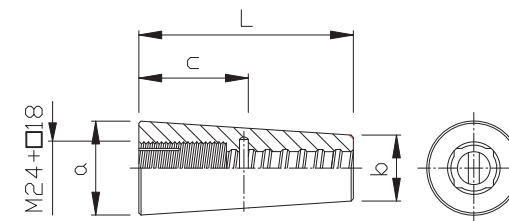

a = Ø43 mm
b = Ø30 mm
c = 50 mm
L = 98 mm

Gewicht | weight 0,57 kg

Tragkraft | working load 90 kN

Werkstoff | material S355J2



PE-Hülse für Vorlaufkonus Typ 30 + 30 / M 24
PE-sleeve for steel cone type 30 + 30 / M24

15F 15 030 K

a = Ø43 mm
b = Ø30 mm
L = 95 mm

Gewicht | weight 0,02 kg

Werkstoff | material PE

Zum einfachen Ausschrauben des Stahlkonus Typ 30 + 30 / M24. PE-Hülse wird vor der Montage auf den Konus gesteckt und verbleibt im Beton.
To ensure easy unscrewing of steel cone type 30 + 30 / M24. The PE-sleeve is put on the cone before installation and remains in the concrete.

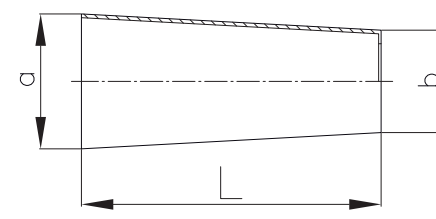

Nagelplatte für Vorlaufkonus Typ 30 / M24 | nail plate for cone type 30 / M24

15F 15 030 N

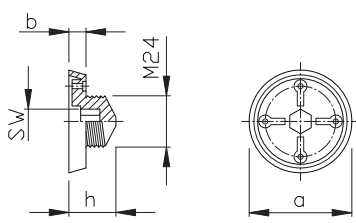

a = Ø48mm
b = 8mm
h = 22mm
SW = 10mm
Gewicht | weight 0,01 kg
Werkstoff | material PE



Vorlaufkonus Typ 30 | cone type 30

15F 17 030

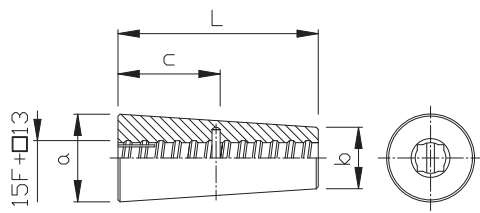

a = Ø43mm
b = Ø30mm
c = 50mm
L = 98mm
Gewicht | weight 0,57 kg
Tragkraft | working load 90 kN
Werkstoff | material S355J2



Nagelplatte für Vorlaufkonus Typ 30 | nail plate for cone type 30

15F 17 030 N

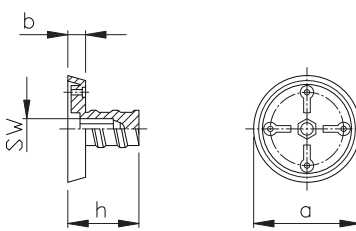

a = Ø48mm
b = 8mm
h = 32mm
SW = 8mm
Gewicht | weight 0,01 kg
Werkstoff | material PE



Anschweißstück¹ | welding bolt

15F 20 030

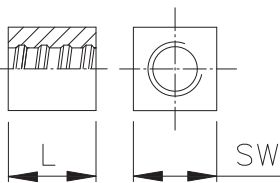

L = 30mm
SW = □30mm
Gewicht | weight 0,16 kg
Tragkraft | working load 60 kN
Werkstoff | material S355J2



Anschweißstück¹ | welding bolt

15F 20 050

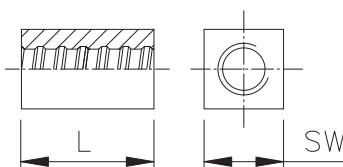

L = 50mm
SW = □30mm
Gewicht | weight 0,26 kg
Tragkraft | working load 90 kN
Werkstoff | material S355J2



¹Nachweis der Schweißnaht nach DIN 18800/Kehlnaht > 3 mm.
Proof of welding acc. DIN 18800/welded seam > 3 mm.

Sechskantmutter | hexagonal nut

schwarz | black 15F 22 030
verzinkt | galvanized 15F 22 030 G

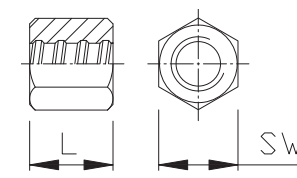

L = 30mm
SW = 30mm
Gewicht | weight 0,10 kg
Tragkraft | working load 60 kN
Werkstoff | material S355J2C+C



Sechskantmutter Volllast | hexagonal nut

schwarz | black 15F 22 050
verzinkt | galvanized 15F 22 050 G

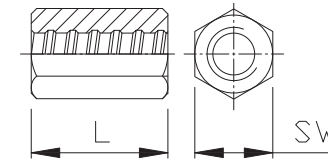

L = 50mm
SW = 30mm
Gewicht | weight 0,20 kg
Tragkraft | working load 90 kN
Werkstoff | material S355J2C+C



Sechskantmutter | hexagonal nut

schwarz | black 15F 22 070
verzinkt | galvanized 15F 22 070 G

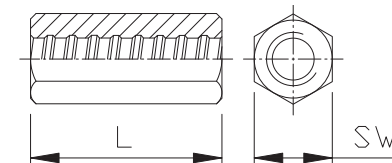

L = 70mm
SW = 30mm
Gewicht | weight 0,30 kg
Tragkraft | working load 90 kN
Werkstoff | material S355J2C+C



Bundmutter | hexagonal nut with extension

verzinkt | galvanized 15F 24 035 G

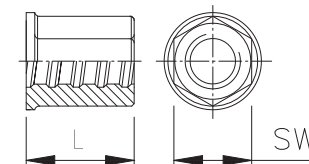

L = 35mm
SW = 30mm
Gewicht | weight 0,14 kg
Tragkraft | working load 60 kN
Werkstoff | material EN-GJMW-400-5 / EN-GJS-500-7



Rundmutter | round nut

schwarz | black 15F 25 070

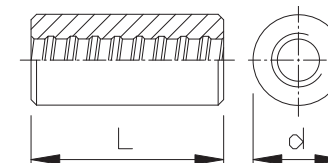

L = 70mm
SW = Ø30mm
Gewicht | weight 0,27 kg
Tragkraft | working load 90 kN
Werkstoff | material S355J2



Anschweißflansch¹ | welding flange

geschmiedet | forged 15F 27 130

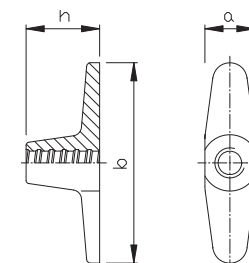

a = 32mm
b = 128mm
h = 47mm
Gewicht | weight 0,39 kg
Tragkraft | working load 90 kN
Werkstoff | material S355J2



¹Nachweis der Schweißnaht nach DIN 18800/Kehlnaht > 3 mm.
Proof of welding acc. DIN 18800/welded seam > 3 mm.

Ø15.0

Verbindungsuffe Sechskant | coupler hexagonal

schwarz | black 15F 28 100
verzinkt | galvanized 15F 28 100 G

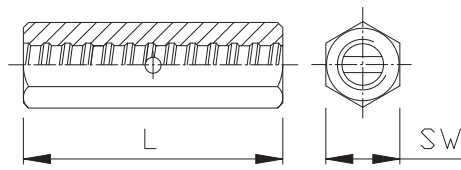

L = 100 mm
SW = 30 mm
Gewicht | weight 0,42 kg
Tragkraft | working load 90 kN
Werkstoff | material S355J2



Ø 15,0 mm

Flanschmutter 3-flügelig | flange nut 3-wings

verzinkt | galvanized 15F 31 070 G

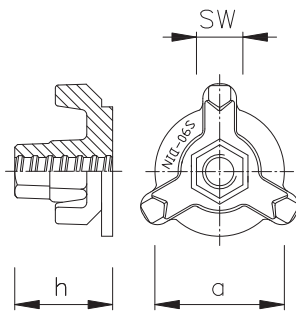

a = Ø70 mm
h = 54 mm
SW = 27 mm
Gewicht | weight 0,43 kg
Gurtungsabstand | girder spacing 35 mm
Tragkraft | working load 90 kN
GE 300
Werkstoff | material EN-GJMW-400-5 / EN-GJS-500-7
EN-GJMW-550-4



Flanschmutter 3-flügelig | flange nut 3-wings

verzinkt | galvanized 15F 31 090 G

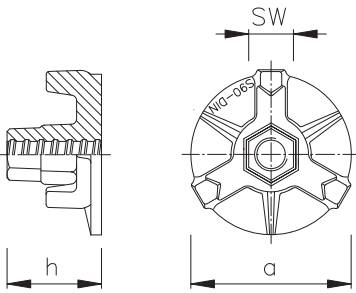

a = Ø95 mm
h = 54 mm
SW = 27 mm
Gewicht | weight 0,66 kg
Gurtungsabstand | girder spacing 35 mm
Tragkraft | working load 90 kN
GE 300
Werkstoff | material EN-GJMW-400-5 / EN-GJS-500-7
EN-GJMW-550-4

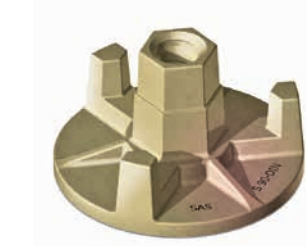

Flanschmutter 3-flügelig | flange nut 3-wings

verzinkt | galvanized 15F 31 100 G

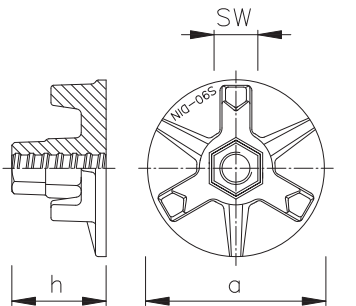

a = Ø100 mm
h = 54 mm
SW = 27 mm
Gewicht | weight 0,70 kg
Gurtungsabstand | girder spacing 50 mm
Tragkraft | working load 90 kN
GE 300
Werkstoff | material EN-GJMW-400-5 / EN-GJS-500-7
EN-GJMW-550-4

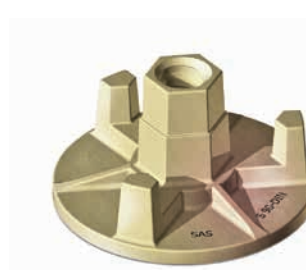

Ø15.0

Flanschmutter 3-flügelig | flange nut 3-wings

verzinkt | galvanized 15F 31 110 G

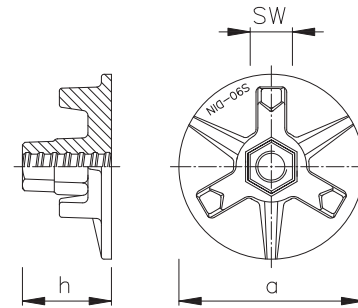

a = Ø110 mm
h = 54 mm
SW = 27 mm
Gewicht | weight 0,85 kg
Gurtungsabstand | girder spacing 50 mm
Tragkraft | working load 90 kN
GE 300
Werkstoff | material EN-GJMW-400-5 / EN-GJS-500-7
EN-GJMW-550-4

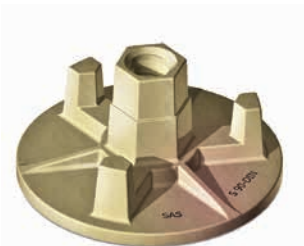

Ø 15,0 mm

Flanschmutter 3-flügelig | flange nut 3-wings

verzinkt | galvanized 15F 31 130 G

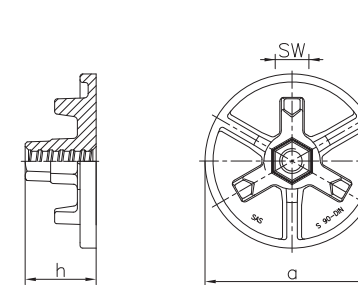

a = Ø130 mm
h = 54 mm
SW = 27 mm
Gewicht | weight 1,16 kg
Gurtungsabstand | girder spacing 50 mm
Tragkraft | working load 90 kN
GE 300
Werkstoff | material EN-GJMW-400-5 / EN-GJS-500-7
EN-GJMW-550-4

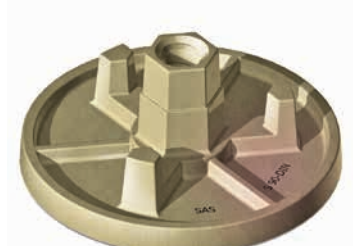

Flügelmutter | wing nut

verzinkt | galvanized 15F 32 026 G

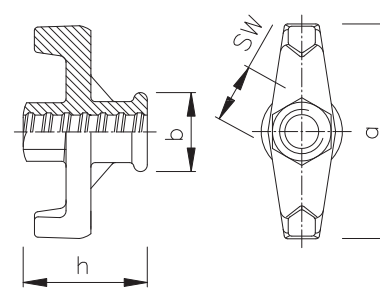

a = 95 mm
b = Ø36 mm
h = 54 mm
SW = 27 mm
Gewicht | weight 0,32 kg
Tragkraft | working load 90 kN
GE 300
Werkstoff | material EN-GJMW-400-5 / EN-GJS-500-7
EN-GJMW-550-4



Wassersperre mit Innenaufnahme für PVC-Rohre Ø26
waterstop for Ø26 plastic spacer tubes

15F 41 130

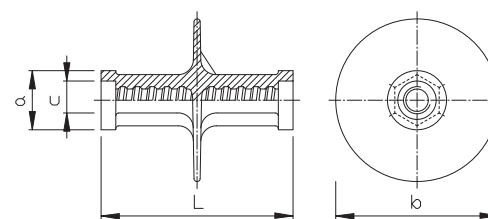

a = Ø40 mm
b = Ø110 mm
c = Ø26 mm
L = 130 mm
Gewicht | weight 0,95 kg
Tragkraft | working load 90 kN
Werkstoff | material EN-GJMW-400-5 / EN-GJS-500-7
EN-GJMW-550-4



Ø15.0

Anschlusskupplung für PVC / Faserbetonrohre | adaptor for spacer tubes

15F 41 130 A

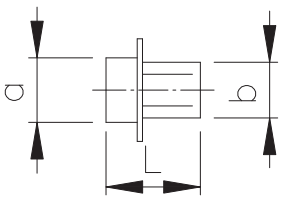

- a = Ø26 mm
- b = Ø22 mm
- L = 33 mm



Gewicht | weight 1,09 kg / Verpackungseinheit (250 Stück)
1,09 kg / packing unit (250 pieces)
Werkstoff | material PE

Ø 15,0 mm

Wassersperre / Stab mit aufgeschweißter Scheibe
waterstop / tie rod with welded plate

Typ FA 15FA 43 000
Typ FS 15FS 43 000

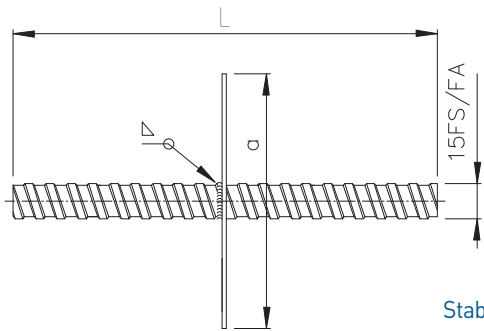

- a = 120 mm
- L = variabel | variable
- Toleranz | tolerance ± 5 mm

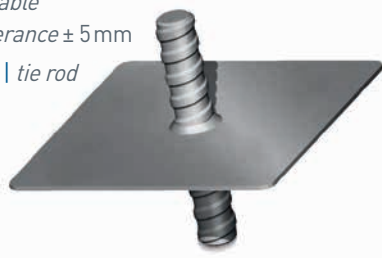

Gewicht | weight 0,22 kg + Stab | tie rod
Tragkraft | working load 80 / 90 kN
Werkstoff | material:
Platte | plate S235JR
Stab | tie rod 15 FS/FA

Stablänge bei Verwendung mit Stahl-Kunststoffkonus: Wandstärke minus 10 cm.
Length in combination with steel-plastic cone: thickness of wall minus 10 cm.

Anschlusskupplung für PVC / Faserbetonrohre
adaptor for plastic spacer tubes

15F 44 110 A

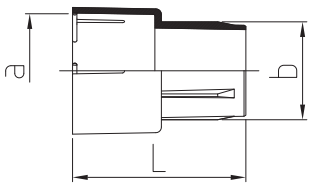

- a = Ø26 mm
- b = Ø22 mm
- L = 40 mm



Gewicht | weight 0,90 kg / Verpackungseinheit (250 Stück)
0,90 kg / packing unit (250 pieces)
Werkstoff | material HDPE / PP

Wassersperre mit Absatz Ø26 | waterstop with landing Ø26

15F 44 110 S

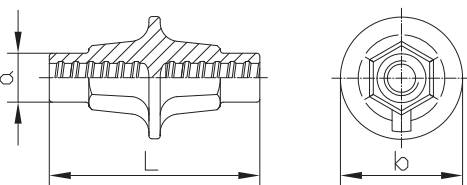

- a = Ø26 mm
- b = Ø65 mm
- L = 112 mm



Gewicht | weight 0,56 kg
Tragkraft | working load 90 kN
Werkstoff | material EN-GJMW-400-5 / EN-GJS-500-7
EN-GJMW-550-4

Ø15.0

Unterlagsplatte geprägt | washer stamped

verzinkt | galvanized 15F 52 010 G

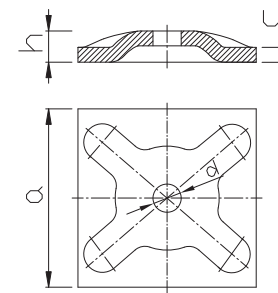

- a = 120 mm
- c = 10 mm
- h = 21 mm
- d = 20 mm

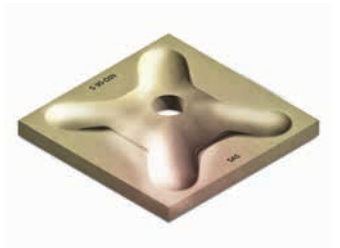

Gewicht | weight 1,10 kg
Tragkraft | working load 90 kN
Werkstoff | material S235JR

Ø 15,0 mm

Unterlagsplatte geprägt | washer stamped

verzinkt | galvanized 15F 54 010 G

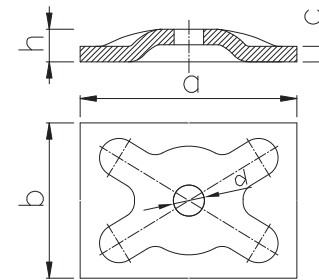

- a = 140 mm
- b = 100 mm
- c = 10 mm
- h = 21 mm
- d = 20 mm

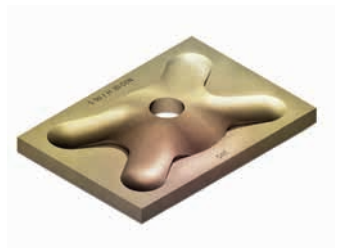

Gewicht | weight 1,15 kg
Tragkraft | working load 90 kN
Werkstoff | material S235JR

Unterlagsplatte geprägt | washer stamped

verzinkt | galvanized 15F 55 010 G

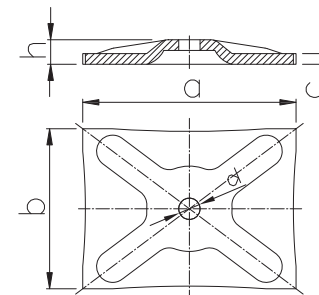

- a = 200 mm
- b = 150 mm
- c = 10 mm
- h = 23 mm
- d = 20 mm

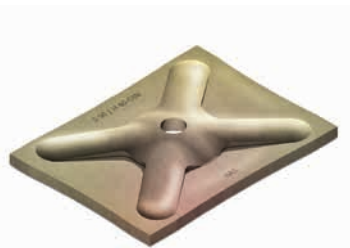

Gewicht | weight 2,26 kg
Tragkraft | working load 90 kN
Werkstoff | material S235JR

Montageanker klein | fix anchor small

15F 61 055

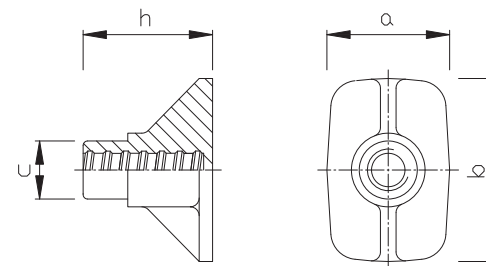

- a = 56 mm
- b = 82 mm
- c = Ø26 mm
- h = 58 mm



Gewicht | weight 0,45 kg
Einbindetiefe | embedding depth 108 mm
Betongüte | concrete strength ≥ C 20/25
≥ 25 MPa
Werkstoff | material EN-GJMW-400-5 / EN-GJS-500-7
EN-GJMW-550-4

Zusatzbewehrung nach statischem Nachweis erforderlich.
Additional reinforcement acc. to analysis.

Montageanker groß | fix anchor large

15F 61 070

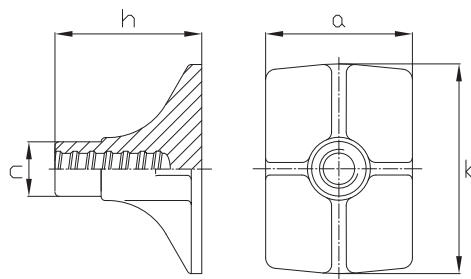

- a = 70 mm
- b = 100 mm
- c = Ø26 mm
- h = 70 mm
- Gewicht | weight 0,60 kg
- Einbindetiefe | embedding depth 118 mm
- Betongüte | concrete strength $\geq C 20/25$
 $\geq 25 \text{ MPa}$
- Werkstoff | material EN-GJMW-400-5 / EN-GJS-500-7
EN-GJMW-550-4



Zusatzbewehrung nach statischem Nachweis erforderlich.
Additional reinforcement acc. to analysis.

Kunststofffuß für Montageanker groß + klein
plastic coupler for fix anchor large + small

15F 62 055

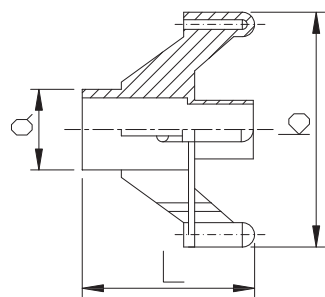

- a = Ø33 mm
- b = Ø98 mm
- L = 70 mm
- Gewicht | weight 0,04 kg
- Für Montageanker | for fix anchor 15F 61 070 + 15F 61 055
- Werkstoff | material PE



Stopfen für Kunststofffuß für Montageanker groß + klein
PE-plug for plastic coupler for fix anchor large + small

15F 62 055 A

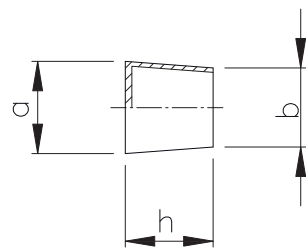

- a = 21 mm
- b = 18 mm
- h = 20 mm
- Gewicht | weight 0,002 kg
- Werkstoff | material PE
- für Kunststofffuß | for plastic coupler 15F 62 055



Beton-/ Felsanker 2-schalig | expansion shell 2-leaf

15F 63 034

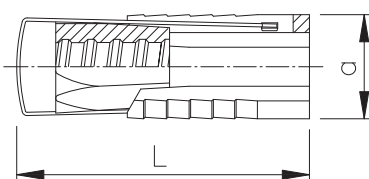

- a = Ø32 mm
- L = 90 mm
- Gewicht | weight 0,22 kg
- Tragkraft | working load 60 kN
- Werkstoff | material EN-GJMW-400-5 / EN-GJS-500-7
- Bohrloch | bore hole Ø33 - 35 mm



Montage nach Einbauanweisung (siehe Seite 47-48)
Assembling acc. to installation manual (page 47-48)

Beton-/ Felsanker 3-schalig | expansion shell 3-leaf

15F 63 037

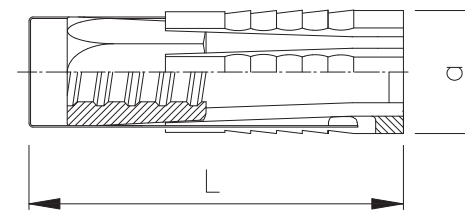

- a = Ø33 mm
- L = 120 mm
- Gewicht | weight 0,37 kg
- Tragkraft | working load 90 kN
- Werkstoff | material EN-GJMW-400-5 / EN-GJS-500-7
- Bohrloch | bore hole Ø35 - 37 mm
- Montage nach Einbauanweisung (siehe Seite 47-48)
Assembling acc. to installation manual (page 47-48)



Plattenanker | plate anchor

Typ FS

15FS 63 160

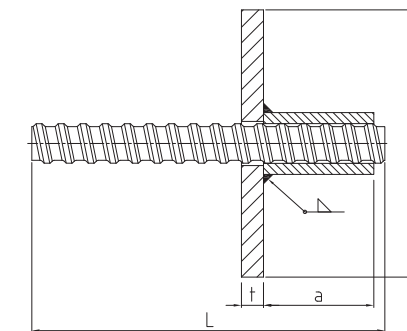

- a = 50 mm
- b = □100 mm
- t = 10 mm
- L = 160 mm bzw. variabel | or variable
- Toleranz | tolerance $\pm 5 \text{ mm}$
- Gewicht | weight 1,16 kg
- Betongüte | concrete strength $\geq C 20/25$
 $\geq 25 \text{ MPa}$
- Werkstoff Platte | material plate S235JR
- Vorlänge | front length 100 mm
- Zusatzbewehrung nach statischen Nachweisen erforderlich.
Additional reinforcement acc. to analysis.

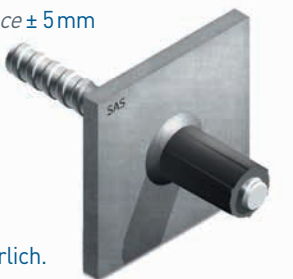

Kombiplatte | combi plate

verzinkt | galvanized

15F 72 010 G

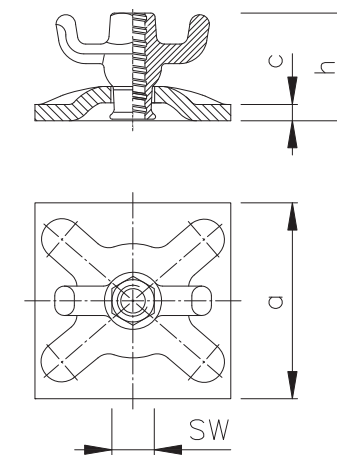

- a = □120 mm
- c = 10 mm
- h = 67 mm
- SW = 27 mm
- Gewicht | weight 1,35 kg
- Tragkraft | working load 90 kN
- Werkstoff | material:
Platte | plate S235JR
Mutter | nut GE 300 / C 35
- Flügelmutter beweglich um ca. 4°
Wing nut moveable appr. 4°

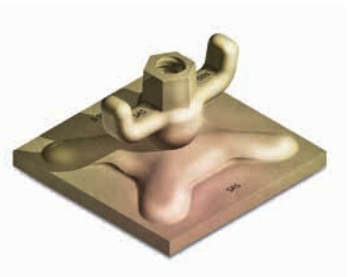

Ø15.0

Ø15.0

Kalottenplatte, quadratisch | dome plate, square

verzinkt | galvanized 15F 72 120 G

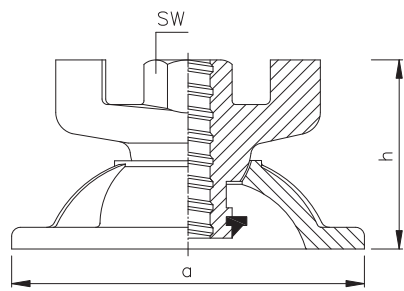

a = 120 mm
 h = 65 mm
 SW = 27 mm
 Gewicht | weight 1,26 kg
 Tragkraft | working load 90 kN
 Werkstoff | material GE 300 / C 35
 EN-GJMW-400-5 / EN-GJS-500-7
 S355J2 / EN-GJMW-550-4

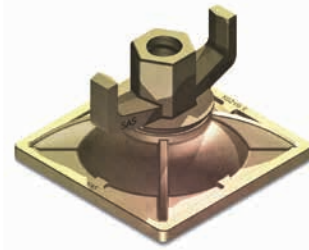

Flügelmutter beweglich um ca. 8°
 Wing nut moveable appr. 8°

Kombiplatte | combi plate

verzinkt | galvanized 15F 75 010 G

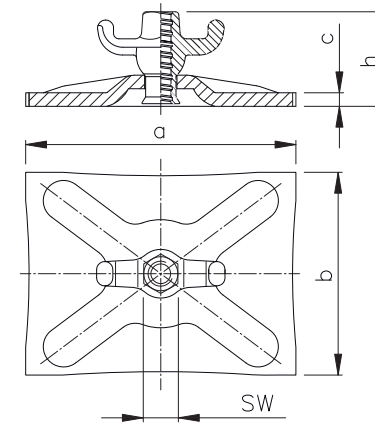

a = 200 mm
 b = 150 mm
 c = 10 mm
 h = 68 mm
 SW = 27 mm
 Gewicht | weight 2,61 kg
 Tragkraft | working load 90 kN
 Werkstoff | material:
 Platte | plate S235JR
 Mutter | nut GE 300 / C 35



Flügelmutter beweglich um ca. 5°
 Wing nut moveable appr. 5°

Kalottenplatte, rund | dome plate, round

verzinkt | galvanized 15F 73 130 G

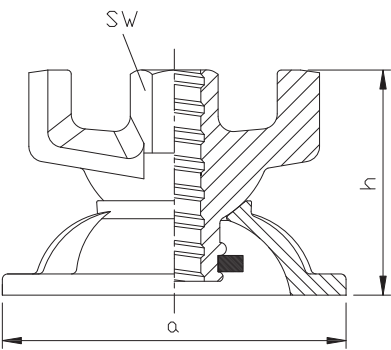

a = Ø130 mm
 h = 65 mm
 SW = 27 mm
 Gewicht | weight 1,07 kg
 Tragkraft | working load 90 kN
 Werkstoff | material GE 300 / C 35
 EN-GJMW-400-5 / EN-GJS-500-7
 S355J2 / EN-GJMW-550-4

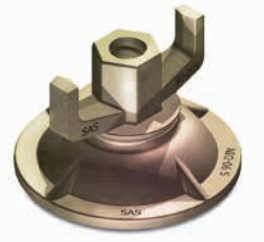

Flügelmutter beweglich um ca. 9°
 Wing nut moveable appr. 9°

Kombiplatte | combi plate

verzinkt | galvanized 15F 74 010 G

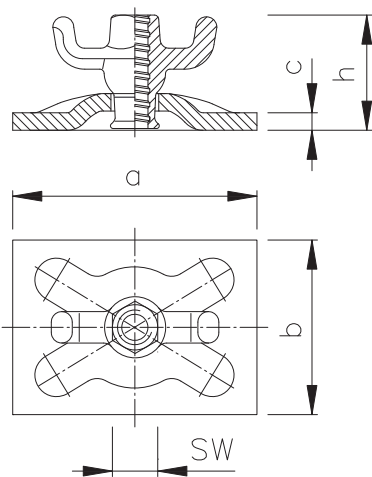

a = 140 mm
 b = 100 mm
 c = 10 mm
 h = 65 mm
 SW = 27 mm
 Gewicht | weight 1,34 kg
 Tragkraft | working load 90 kN
 Werkstoff | material:
 Platte | plate S235JR
 Mutter | nut GE 300 / C 35



Flügelmutter beweglich um ca. 5°
 Wing nut moveable appr. 5°

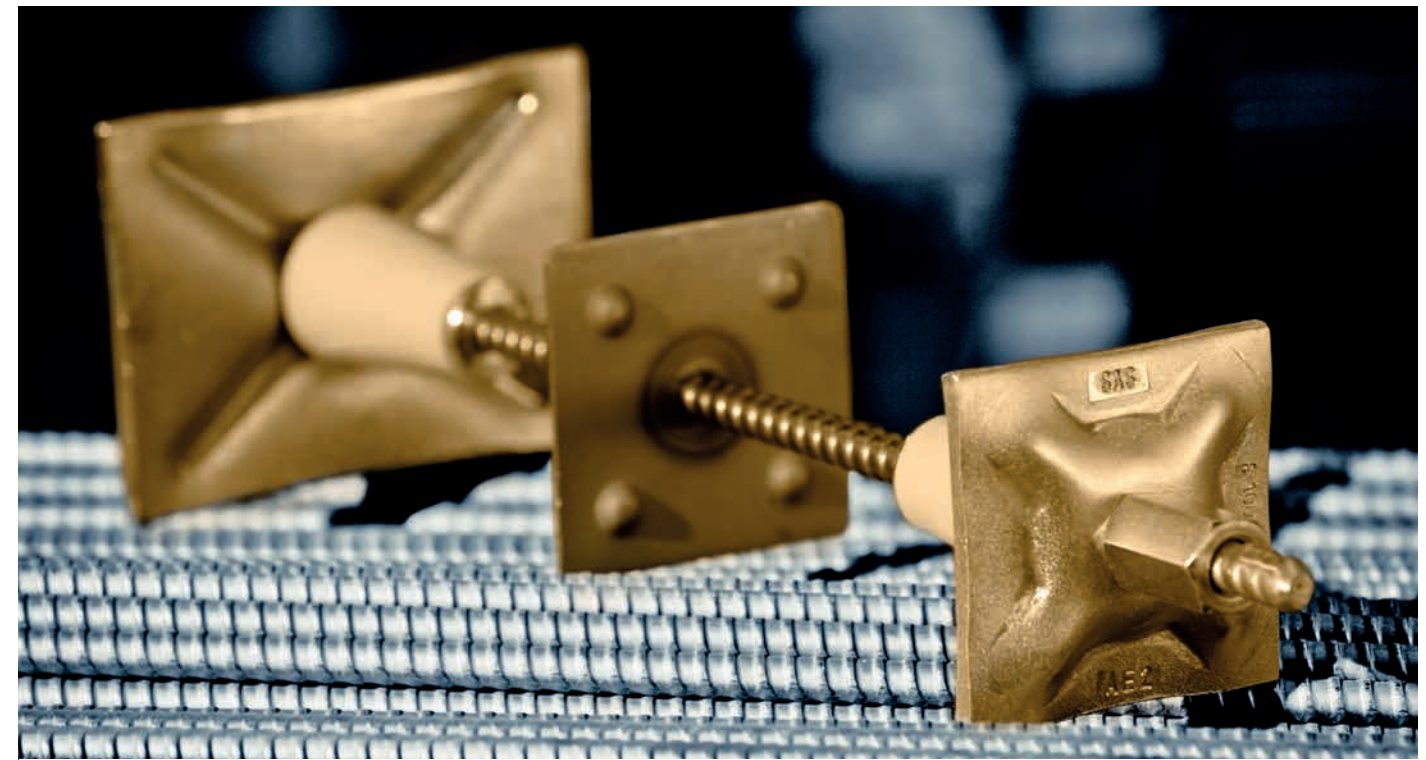

SAS LokTie - Zugstabsystem | Tie Rod System
ohne Muffe | without coupler

feuerverzinkt
hot-dip galvanized 15F 80 120 FV

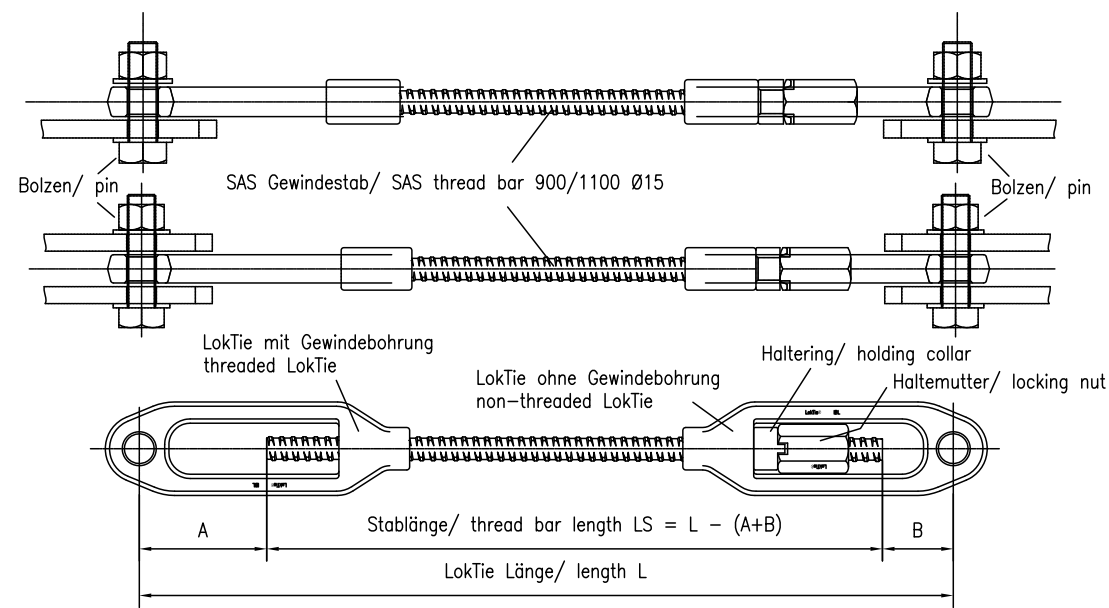

A = 130 bis 80 mm

B = 65 bis 45 mm

Tragkraft | working load 92,1 kN

gemäß Zulassung | acc. approval Z - 14.4 - 565

SAS LokTie - Zugstabsystem | Tie Rod System
mit Muffe | with coupler

feuerverzinkt
hot-dip galvanized 15F 80 120 FV

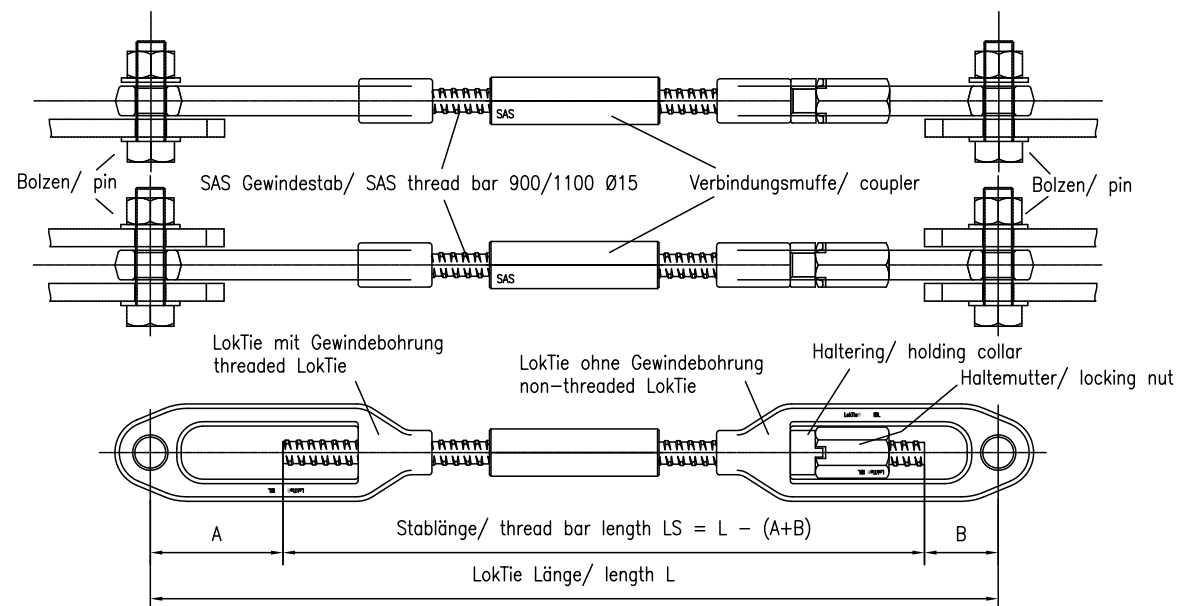

A = 130 bis 80 mm

B = 65 bis 45 mm

Tragkraft | working load 73,3 kN

gemäß Zulassung | acc. approval Z - 14.4 - 565

SAS LokTie

LokTie mit Gewinde / ohne Gewinde
LokTie with thread / without thread

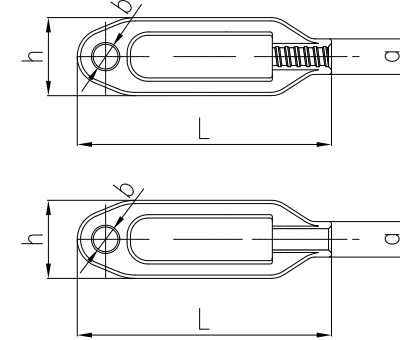

feuerverzinkt
hot-dip galvanized 15F 80 120 FV

a = Ø30 mm

b = Ø21 mm

h = 66 mm

L = 215 mm

Werkstoff | material G 34 CrMo 4 + QT 1

Gewicht | weight mit Gewinde | with thread = 1,01 kg

ohne Gewinde | without thread = 1,02 kg

Haltermutter | locking nut

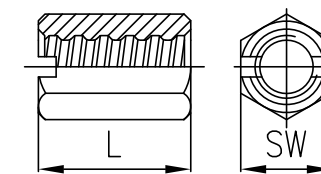

L = 50 mm

SW 30 mm

Werkstoff | material G 34 CrMo 4 + QT 1

Gewicht | weight 0,20 kg

Haltering | locking ring

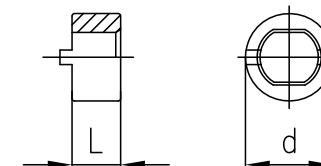

L = 17 mm

d = 30 mm

Werkstoff | material G 34 CrMo 4 + QT 1

Gewicht | weight 0,06 kg

Verbindungsmuffe, rund | coupler, round

feuerverzinkt
hot-dip galvanized 15F 25 115 FV

L = 115 mm

d = 32 mm

Werkstoff | material S355J2

Gewicht | weight 0,38 kg

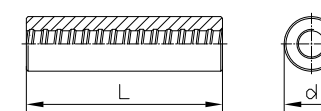

Sechskantmutter | hexagonal nut

feuerverzinkt
hot-dip galvanized 15F 22 030 FV

L = 30 mm

SW 30 mm

Werkstoff | material S355J2C+C

Gewicht | weight 0,10 kg

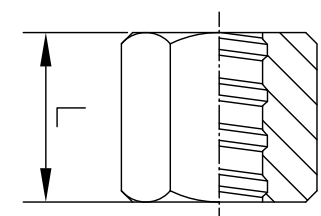

Verwendung nur zur Lagesicherung | Use only for fixing position

SAS Schalungsanker Typ FA¹ gewalzt, schweißbar
SAS Tie Rod Type FA hot rolled, weldable

schwarz | black 20FA...
verzinkt | galvanized 20FA...G

$a_1 = 20\text{ mm}$
 $a_2 = 23\text{ mm}$
L = variabel bis max. 15 m | variable up to max. 15 m
L = verzinkt max. 6 m | galvanized max. 6 m

Gewicht | weight 2,56 kg/m
Tragkraft | working load 160 kN
Werkstoff | material SAS 900/1100

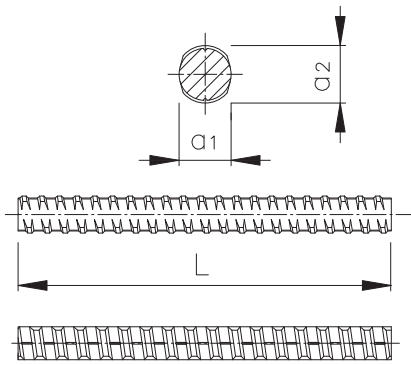

SAS Schalungsanker Typ FC gewalzt | SAS Tie Rod Type FC hot rolled

schwarz | black 20FC...
verzinkt | galvanized 20FC...G

$a_1 = 20\text{ mm}$
 $a_2 = 23\text{ mm}$
L = variabel bis max. 15 m | variable up to max. 15 m
L = verzinkt max. 6 m | galvanized max. 6 m

Gewicht | weight 2,56 kg/m
Tragkraft | working load 160 kN
Werkstoff | material SAS 900/1050

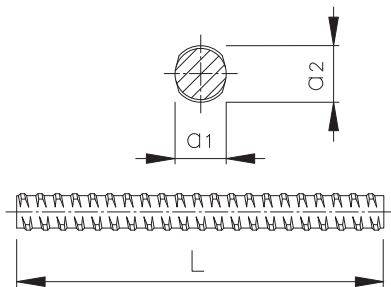

SAS Schalungsanker Typ FS gerollt, schweißbar
SAS Tie Rod Type FS cold rolled, weldable

schwarz | black 20FS...
verzinkt | galvanized 20FS...G

$a_1 = 20\text{ mm}$
 $a_2 = 23\text{ mm}$
L = variabel bis max. 6 m | variable up to max. 6 m
Gewicht | weight 2,56 kg/m
Tragkraft | working load 140 kN
Werkstoff | material SAS 750 / 875

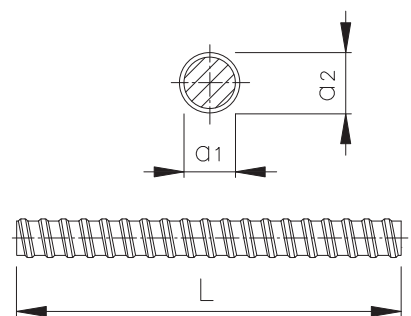

¹Kennzeichnung: Längsnuten zwischen Rippen
Marking: Longitudinal slots between ribs

Wellenanker | wave anchor

Typ FA 20FA 66 700 W

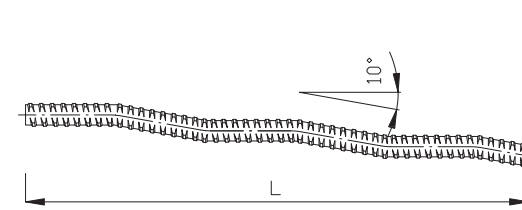

L = 700 mm
Gewicht | weight 1,79 kg
Betongüte | concrete strength $\geq C 20/25$
 $\geq 25\text{ MPa}$
Tragkraft | working load 160 kN
Werkstoff | material SAS 900/1100



Hakenanker | hook anchor

Typ FA 20FA 64 600 H

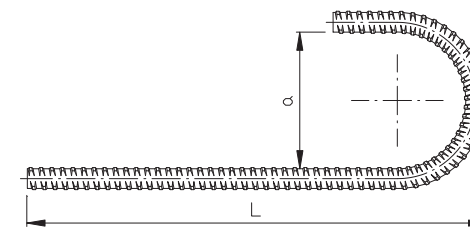

$a = 150\text{ mm}$
L = 600 mm
Gewicht | weight 2,23 kg
Betongüte | concrete strength $\geq C 20/25$
 $\geq 25\text{ MPa}$
Tragkraft | working load 160 kN
Werkstoff | material SAS 900/1100



Ø 20,0 mm

Schlaufenanker | loop anchor

Typ FA 20FA 65 600 S

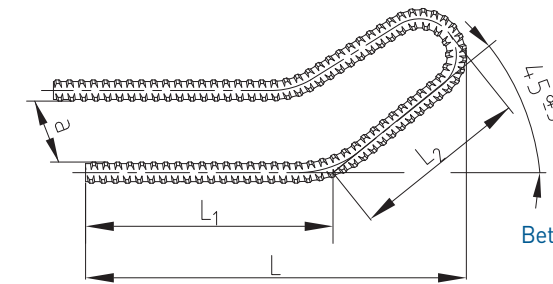

$a = 300\text{ mm}$
L = 600 mm
 $L_1 = 380\text{ mm}$
 $L_2 = 320\text{ mm}$
Gewicht | weight 3,94 kg
Betongüte | concrete strength $\geq C 20/25$
 $\geq 25\text{ MPa}$
Tragkraft | working load 160 kN je Stabende | on each bar end
Werkstoff | material SAS 900/1100



Stahlkonus Typ 33 | steel cone type 33

verzinkt | galvanized 20F 12 033

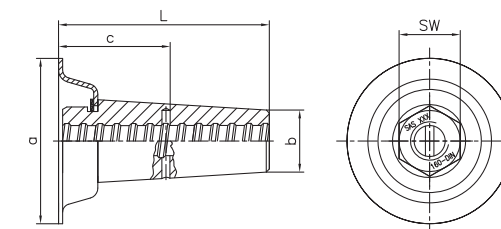

$a = \text{Ø}80\text{ mm}$
 $b = \text{Ø}33\text{ mm}$
 $c = 68\text{ mm}$
L = 129 mm
SW = 36 mm
Gewicht | weight 1,00 kg
Tragkraft | working load 160 kN
Werkstoff | material S355J2



Stahl-Kunststoffkonus Typ MKK | steel-plastic cone type MKK

verzinkt | galvanized 20F 14 126

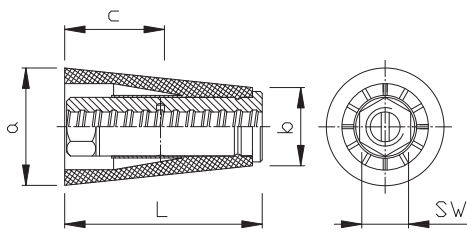

a = Ø70 mm
 b = Ø45 mm
 c = 65 mm
 L = 126 mm
 SW = 32 mm
 Gewicht | weight 0,80 kg
 Tragkraft | working load 160 kN
 Werkstoff | material S355J2 + PP, C45



Betonstopfen für Stahl-Kunststoffkonus Typ MKK
 concrete plug for steel-plastic cone type MKK

20F 14 126 S

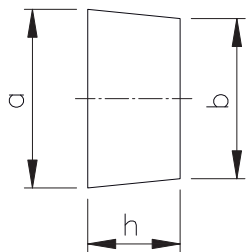

a = Ø69 mm
 b = Ø60 mm
 h = 40 mm
 Gewicht | weight 0,20 kg
 Werkstoff | material Beton | concrete



Zum Verschließen der Konuslöcher des Stahl-Kunststoffkonus.
 For sealing of cone holes of the steel-plastic cone.

Anschweißstück¹ | welding bolt

20F 20 060

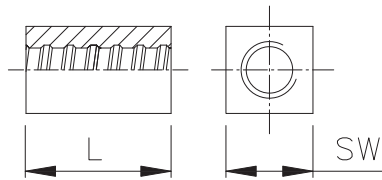

L = 60 mm
 SW = □40 mm
 Gewicht | weight 0,57 kg
 Tragkraft | working load 160 kN
 Werkstoff | material S355J2



Sechskantmutter | hexagonal nut

schwarz | black 20F 22 030
 verzinkt | galvanized 20F 22 030 G

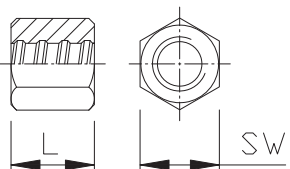

L = 30 mm
 SW = 36 mm
 Gewicht | weight 0,17 kg
 Tragkraft | working load 70 kN
 Werkstoff | material S355J2C+C



Sechskantmutter Volllast | hexagonal nut

schwarz | black 20F 22 060
 verzinkt | galvanized 20F 22 060 G

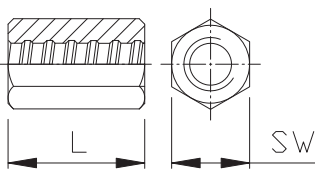

L = 60 mm
 SW = 36 mm
 Gewicht | weight 0,34 kg
 Tragkraft | working load 160 kN
 Werkstoff | material S355J2C+C



¹Nachweis der Schweißnaht nach DIN 18800/Kehlnaht > 3 mm.
 Proof of welding acc. DIN 18800/welded seam > 3 mm.

Verbindungsmuffe Sechskant | coupler hexagonal

schwarz | black 20F 28 110
 verzinkt | galvanized 20F 28 110 G

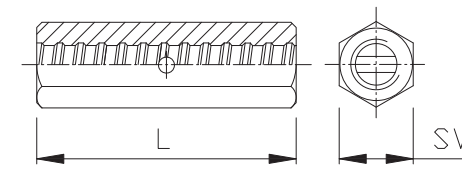

L = 110 mm
 SW = 36 mm
 Gewicht | weight 0,63 kg
 Tragkraft | working load 160 kN
 Werkstoff | material S355J2C+C



Flanschmutter 3-flügelig | flange nut 3-wings

verzinkt | galvanized 20F 31 130 G

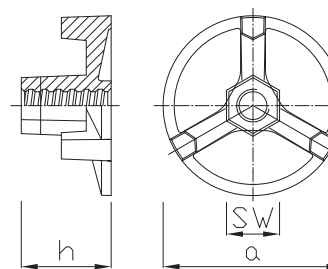

a = Ø130 mm
 h = 65 mm
 SW = 36 mm
 Gewicht | weight 1,54 kg
 Gurtungsabstand | girder spacing 50 mm
 Tragkraft | working load 160 kN
 Werkstoff | material EN-GJMW-400-5 / EN-GJS-500-7
 EN-GJMW-550-4



Flügelmutter | wing nut

verzinkt | galvanized 20F 32 036 G

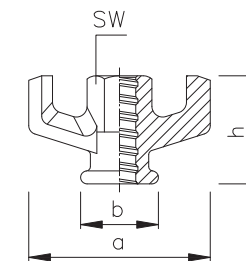

a = 110 mm
 b = Ø42 mm
 h = 60 mm
 SW = 36 mm
 Gewicht | weight 0,45 kg
 Tragkraft | working load 160 kN
 Werkstoff | material EN-GJMW-400-5 / EN-GJS-500-7
 EN-GJMW-500-4



Wassersperre mit Absatz Ø31 x 20 | waterstop with landing Ø31 x 20

20F 41 150

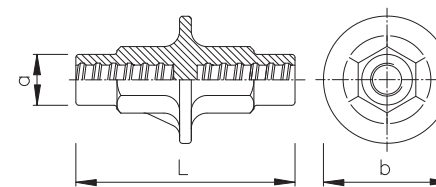

a = Ø31 mm
 b = Ø90 mm
 L = 150 mm
 Gewicht | weight 1,39 kg
 Tragkraft | working load 160 kN
 Werkstoff | material EN-GJMW-400-5 / EN-GJS-500-7
 EN-GJMW-500-4



Wassersperre / Stab mit aufgeschweißter Scheibe
waterstop / tie rod with welded plate

Typ FA 20FA 43 000
Typ FS 20FS 43 000

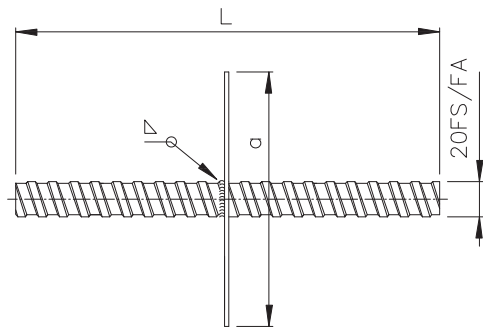

a = □120mm
L = variabel | variable
Toleranz | tolerance ± 5mm
Gewicht | weight 0,22kg + Stab | tie rod
Tragkraft | working load 140 / 160kN
Werkstoff | material.
Platte | plate S235JR
Stab | Tie Rod 20FS / FA



Stablänge bei Verwendung mit Stahl-Kunststoffkonus: Wandstärke minus 13cm.
Length in combination with steel-plastic cone: thickness of wall minus 13cm.

Vollplatte | plate

20F 52 020

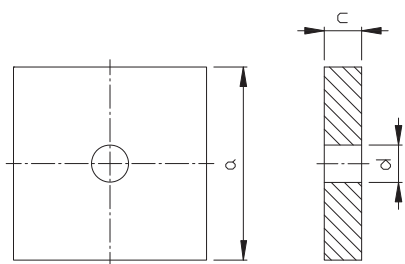

a = □120mm
c = 20mm
d = Ø25mm
Gewicht | weight 2,15kg
Tragkraft | working load 160kN
Gurtungsabstand | girder spacing 50mm
Werkstoff | material S235JR

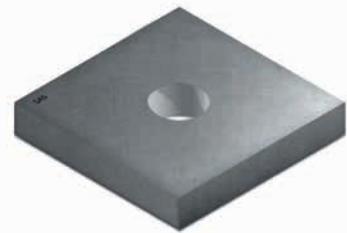

Montageanker | fix anchor

20F 61 080

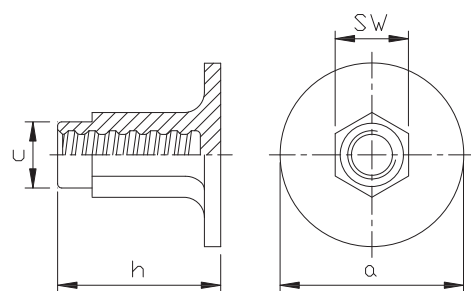

a = Ø90mm
c = Ø31mm
h = 80mm
SW = 39mm
Gewicht | weight 0,78kg
Betongüte | concrete strength ≥ C 20/25
≥ 25 MPa
Werkstoff | material EN-GJMW-400-5 / EN-GJS-500-7 / EN-GJMW-550-4



Zusatzbewehrung nach statischem Nachweis erforderlich.
Additional reinforcement acc. to analysis.

Beton-/ Felsanker 3-schalig | expansion shell 3-leaf

20F 63 053

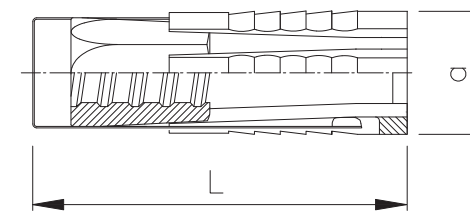

a = Ø39mm
L = 110mm
Gewicht | weight 0,44kg
Bohrloch | bore hole Ø40 - 42mm
Tragkraft | working load 120kN
Werkstoff | material EN-GJMW-400-5 / EN-GJS-500-7



Montage nach Einbauweisung (siehe Seite 47-48)
Assembling acc. to installation manual. (page 47-48)

Plattenanker | plate anchor

Typ FA 20FA 63 275
Typ FS 20FS 63 275

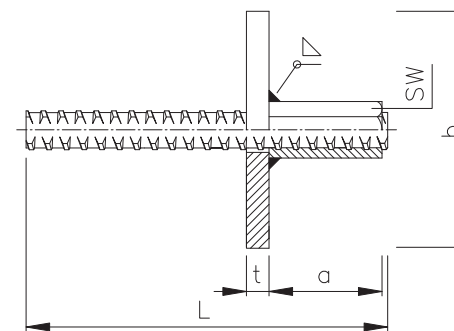

a = 60mm
b = □120mm
SW = 36mm
t = 15mm
L = 275mm bzw. variabel | or variable
Toleranz | tolerance ± 5mm
Gewicht | weight 2,75kg
Betongüte | concrete strength ≥ C 20/25
≥ 25 MPa
Werkstoff Platte | material plate S235JR
Werkstoff Stab | material bar 20FA / 20FS
Vorlänge | front length 200mm
Zusatzbewehrung nach statischen Nachweisen erforderlich.
Additional reinforcement acc. to analysis.

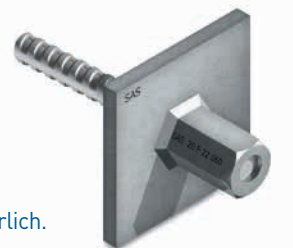

Kalottenplatte, rund | dome plate, round

verzinkt | galvanized 20F 73 130 G

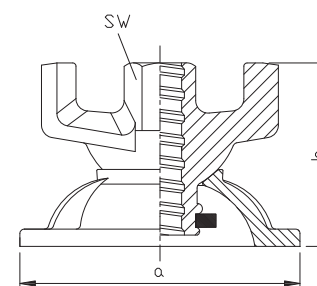

a = Ø130mm
h = 85mm
SW = 36mm
Gewicht | weight 1,80kg
Tragkraft | working load 160kN
GE 300
Werkstoff | material S 355
C 45

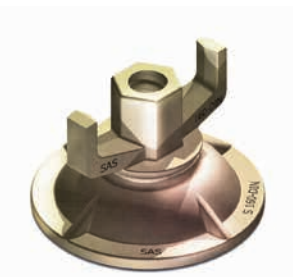

Flügelmutter beweglich um ca. 5°
Wing nut moveable appr. 5°

SAS LokTie - Zugstabsystem | Tie Rod System
ohne Muffe | without coupler

feuerverzinkt
hot-dip galvanized 20F 80 124 FV

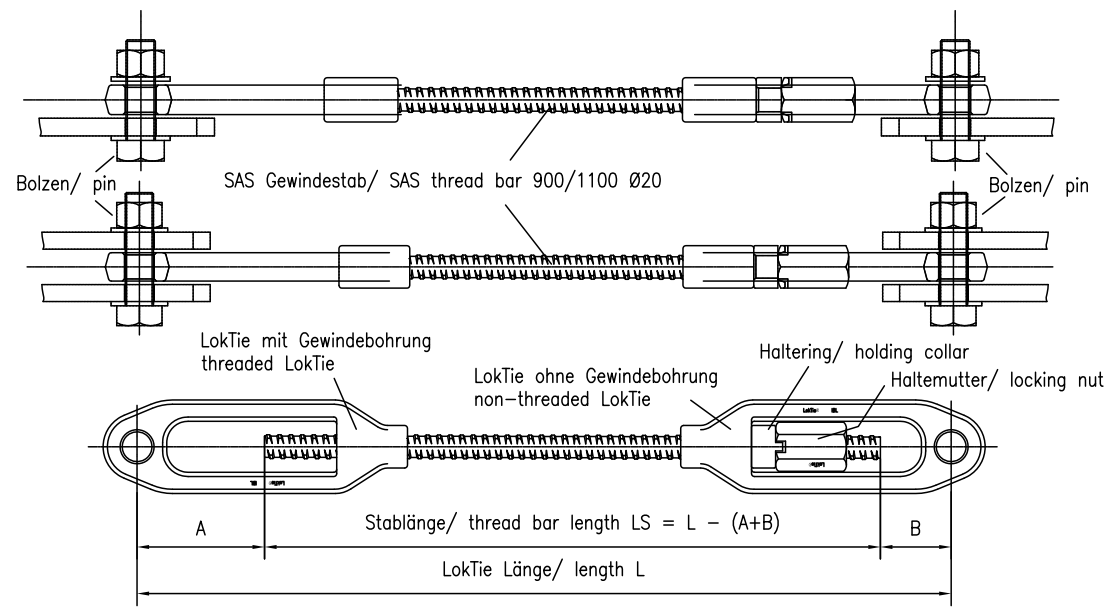

A = 150 bis 95 mm

B = 70 bis 50 mm

Tragkraft | working load 154,7kN

gemäß Zulassung | acc. approval Z - 14.4 - 565

SAS LokTie - Zugstabsystem | Tie Rod System
mit Muffe | with coupler

feuerverzinkt
hot-dip galvanized 20F 80 124 FV

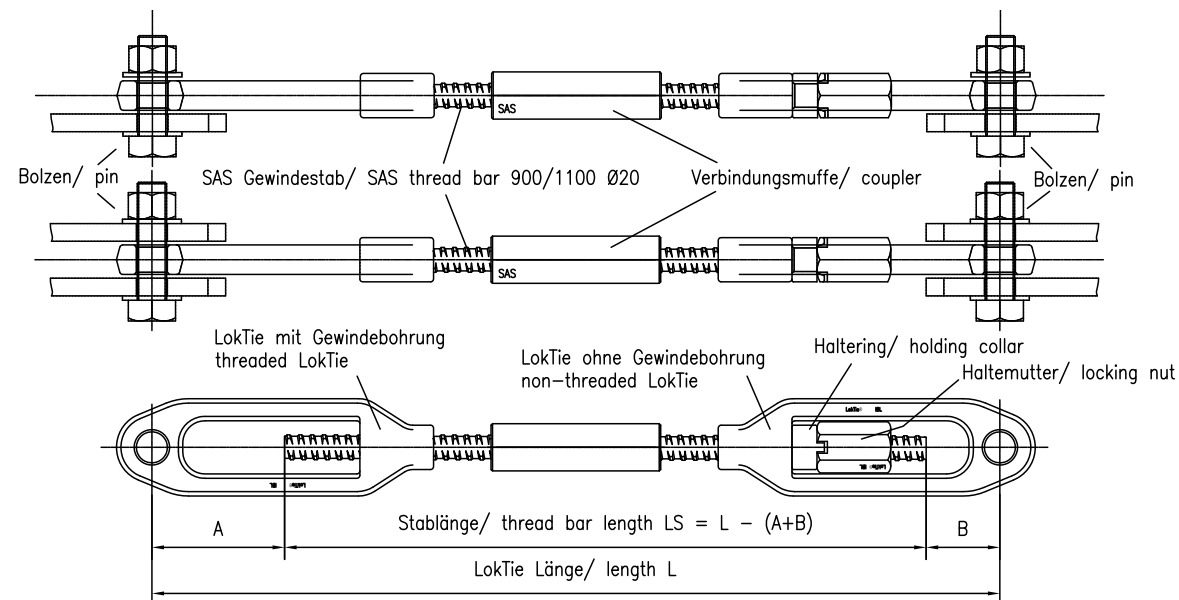

A = 150 bis 95 mm

B = 70 bis 50 mm

Tragkraft | working load 121,5kN

gemäß Zulassung | acc. approval Z - 14.4 - 565

SAS LokTie

feuerverzinkt
hot-dip galvanized 20F 80 124 FV

LokTie mit Gewinde / ohne Gewinde
LokTie with thread / without thread

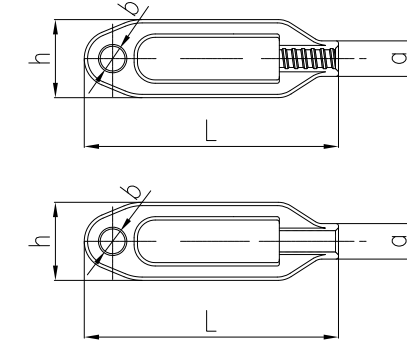

a = Ø36 mm

b = Ø25 mm

h = 84 mm

L = 250 mm

Werkstoff | material: G 34 CrMo 4 + QT 1

Gewicht | weight mit Gewinde | with thread = 1,84 kg

ohne Gewinde | without thread = 1,82 kg

Haltermutter | locking nut

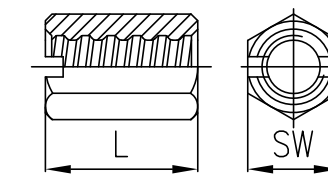

L = 60 mm

SW 36 mm

Werkstoff | material: G 34 CrMo 4 + QT 1

Gewicht | weight 0,33 kg

Haltering | locking ring

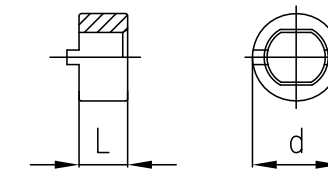

L = 20 mm

d = 36 mm

Werkstoff | material: G 34 CrMo 4 + QT 1

Gewicht | weight 0,09 kg

Verbindungs-muffe, rund | coupler, round

feuerverzinkt
hot-dip galvanized 20F 25 120 FV

L = 120 mm

d = 40 mm

Werkstoff | material: S355J2

Gewicht | weight 0,89 kg

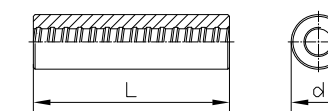

Sechskantmutter | hexagonal nut

feuerverzinkt
hot-dip galvanized 20F 22 030 FV

L = 30 mm

SW 36 mm

Werkstoff | material: S355J2C+C

Gewicht | weight 0,17 kg

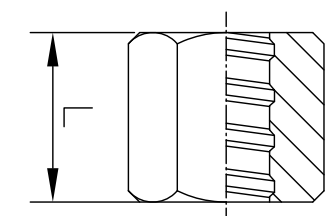

SAS Schalungsanker Typ FA¹ gewalzt, schweißbar
SAS Tie Rod Type FA hot rolled, weldable

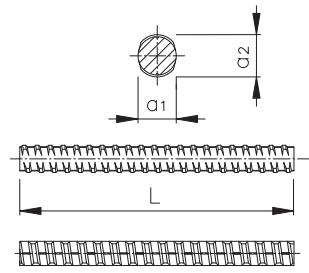

schwarz | black 26FA...
verzinkt | galvanized 26FA...G

$a_1 = 26,5\text{mm}$
 $a_2 = 31\text{mm}$
 $L = \text{variabel bis max. 15m} \mid \text{variable up to max. 15m}$
 $L = \text{verzinkt max. 6m} \mid \text{galvanized max. 6m}$

Gewicht | weight 4,48kg/m
Tragkraft | working load 280kN
Werkstoff | material SAS 900/1100

SAS Schalungsanker Typ E gewalzt | SAS Tie Rod Type E hot rolled

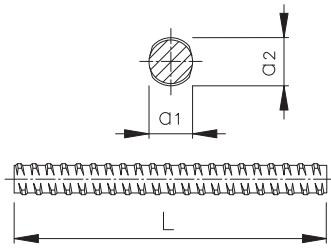

schwarz | black 26E...
verzinkt | galvanized 26E...G

$a_1 = 26,5\text{mm}$
 $a_2 = 31\text{mm}$
 $L = \text{variabel bis max. 15m} \mid \text{variable up to max. 15m}$
 $L = \text{verzinkt max. 6m} \mid \text{galvanized max. 6m}$

Gewicht | weight 4,48kg/m
Tragkraft | working load 300kN
Werkstoff | material SAS 950/1050

Wellenanker | wave anchor

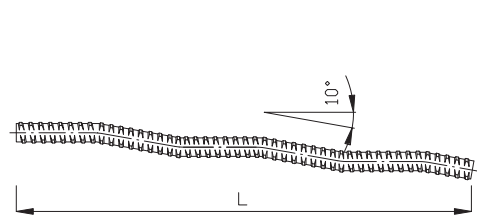

Typ FA 26FA 66 800 W

$L = 800\text{mm}$

Gewicht | weight 3,58kg
Betongüte | concrete strength $\geq C 20/25$
 $\geq 25\text{MPa}$
Tragkraft | working load 220kN
Werkstoff | material SAS 900/1100

Hakenanker | hook anchor

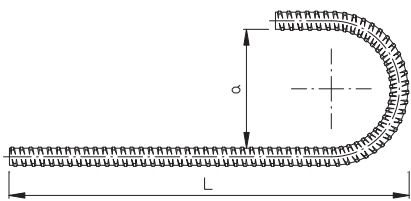

Typ FA 26FA 64 800 H

$a = 260\text{mm}$
 $L = 800\text{mm}$

Gewicht | weight 6,00kg
Betongüte | concrete strength $\geq C 20/25$
 $\geq 25\text{MPa}$
Tragkraft | working load 220kN
Werkstoff | material SAS 900/1100

Schlaufenanker | loop anchor

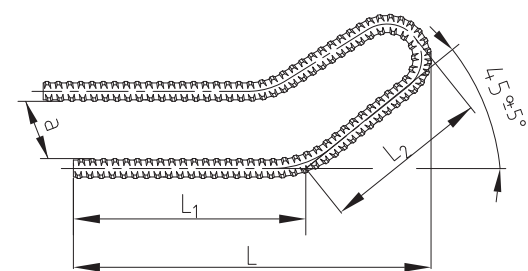

Typ FA 26FA 65 800 S

$a = 350\text{mm}$
 $L = 840\text{mm}$
 $L_1 = 550\text{mm}$
 $L_2 = 360\text{mm}$

Gewicht | weight 8,69kg
Betongüte | concrete strength $\geq C 20/25$
 $\geq 25\text{MPa}$
Tragkraft | working load 280kN je Stabende | on each bar end
Werkstoff | material SAS 900/1100

¹Kennzeichnung: Längsnuten zwischen Rippen
Marking: Longitudinal slots between ribs

Stahlkonus Typ 40 | steel cone type 40

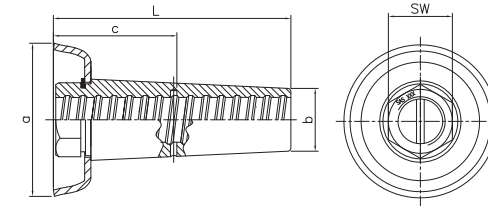

verzinkt | galvanized 26E 12 040

$a = \text{Ø}98\text{mm}$
 $b = \text{Ø}40\text{mm}$
 $c = 80\text{mm}$
 $L = 152\text{mm}$
 $SW = 41\text{mm}$

Gewicht | weight 1,49kg
Tragkraft | working load 280kN
Werkstoff | material S355J2, C45+N



PE-Hülse für Stahlkonus Typ 40 | PE-sleeve for steel cone type 40

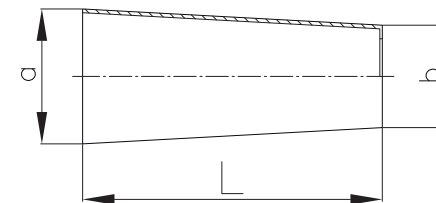

26E 12 040 K

$a = \text{Ø}52,5\text{mm}$
 $b = \text{Ø}40\text{mm}$
 $L = 120\text{mm}$

Gewicht | weight 0,01kg
Werkstoff | material PE

Zum einfachen Ausschrauben des Stahlkonus Typ 40. PE-Hülse wird vor der Montage auf den Konus gesteckt und verbleibt im Beton.
To ensure easy unscrewing of steel cone type 40. The PE-sleeve is put on the cone before installation and remains in the concrete.



Stahl-Kunststoffkonus Typ MKK | steel-plastic cone type MKK

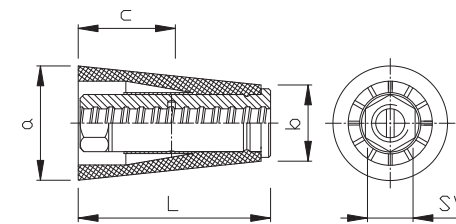

verzinkt | galvanized 26E 14 135

$a = \text{Ø}103\text{mm}$
 $b = \text{Ø}57\text{mm}$
 $c = 70\text{mm}$
 $L = 135\text{mm}$
 $SW = 46\text{mm}$

Gewicht | weight 1,71kg
Tragkraft | working load 250kN
Werkstoff | material S355J0 + PP



Vorlaufkonus Typ 40 / M36 | cone type 40 / M36

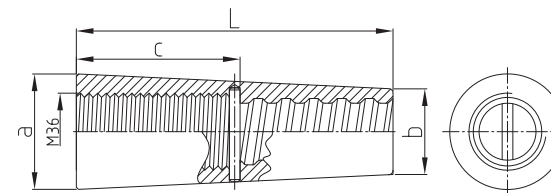

verzinkt | galvanized 26E 15 040

$a = \text{Ø}54\text{mm}$
 $b = \text{Ø}40\text{mm}$
 $c = 76\text{mm}$
 $L = 148\text{mm}$

Gewicht | weight 1,13kg
Tragkraft | working load 240kN
Werkstoff | material S355J2 / C45



PE-Hülse für Vorlaufkonus Typ 40 / M36
PE-sleeve for cone type 40 / M36

26E 15 040 K

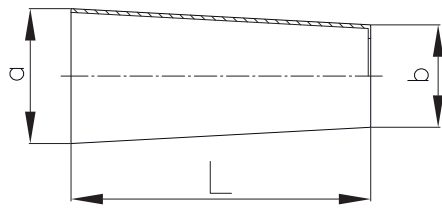

a = Ø54 mm
b = Ø40 mm
L = 145 mm

Gewicht | weight 0,02 kg
Werkstoff | material PE



Zum einfachen Ausschrauben des Stahlkonus Typ 40 / M36. PE-Hülse wird vor der Montage auf den Konus gesteckt und verbleibt im Beton.
To ensure easy unscrewing of steel cone type 40 / M36. The PE-sleeve is put on the cone before installation and remains in the concrete.

Nagelplatte für Vorlaufkonus Typ 40 / M36 | nail plate for cone type 40 / M36

26E 15 040 N

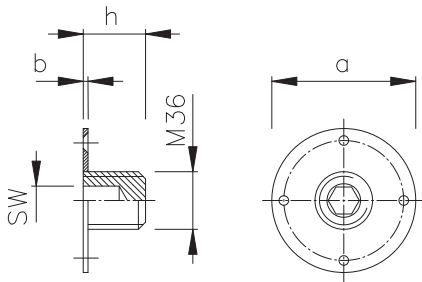

a = Ø75 mm
b = 5 mm
h = 35 mm
SW = 17 mm

Gewicht | weight 0,37 kg
Werkstoff | material Stahl | steel



Sechskantmutter | hexagonal nut

schwarz | black 26E 22 030
verzinkt | galvanized 26E 22 030 G

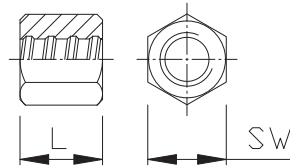

L = 30 mm
SW = 46 mm
Gewicht | weight 0,27 kg
Tragkraft | working load 90 kN
Werkstoff | material S355J2C+C



Sechskantmutter | hexagonal nut

schwarz | black 26E 22 060
verzinkt | galvanized 26E 22 060 G

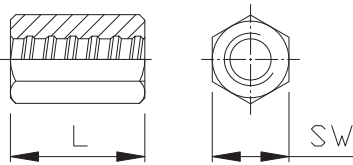

L = 60 mm
SW = 46 mm
Gewicht | weight 0,54 kg
Tragkraft | working load 200 kN
Werkstoff | material S355J2C+C



Sechskantmutter Volllast | hexagonal nut

schwarz | black 26E 22 080
verzinkt | galvanized 26E 22 080 G

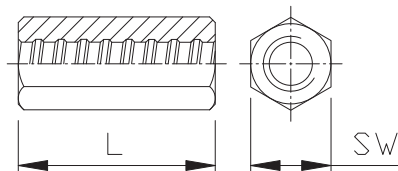

L = 80 mm
SW = 46 mm
Gewicht | weight 0,74 kg
Tragkraft | working load 300 kN
Werkstoff | material S355J2C+C



Verbindungsmuffe kurz, Sechskant | coupler short, hexagonal

schwarz | black 26E 28 120
verzinkt | galvanized 26E 28 120 G

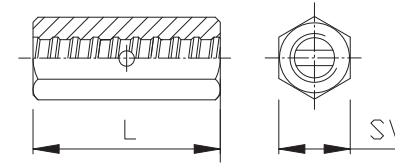

L = 120 mm
SW = 46 mm
Gewicht | weight 1,09 kg
Tragkraft | working load 200 kN
Werkstoff | material S355J2C+C



Verbindungsmuffe Sechskant | coupler hexagonal

schwarz | black 26E 28 150
verzinkt | galvanized 26E 28 150 G

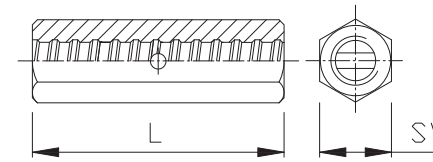

L = 150 mm
SW = 46 mm
Gewicht | weight 1,36 kg
Tragkraft | working load 300 kN
Werkstoff | material S355J2C+C



Flügelmutter | wing nut

verzinkt | galvanized 26E 32 046 G

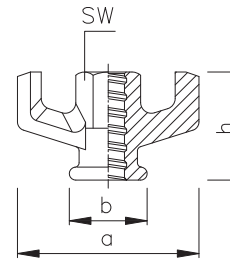

a = 155 mm
b = Ø52 mm
h = 65 mm
SW = 46 mm
Gewicht | weight 0,90 kg
Tragkraft | working load 260 kN
Werkstoff | material EN-GJMW-400-5 / EN-GJS-500-7
EN-GJMW-500-4



Wassersperre / Stab mit aufgeschweißter Scheibe
waterstop / tie rod with welded plate

Typ FA 26FA 43 000

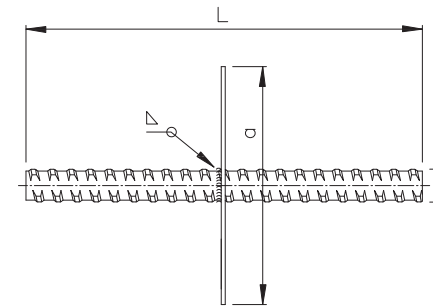

a = □120 mm
L = variabel | variable - Toleranz | tolerance ± 5 mm
Gewicht | weight 0,22 kg + Stab / tie rod
Tragkraft | working load 220 kN
Werkstoff | material:
Platte | plate S235JR
Stab | tie rod 26FA
Stablänge bei Verwendung mit Stahl-Kunststoffkonus: Wandstärke minus 14 cm.
Length in combination with steel-plastic cone: thickness of wall minus 14 cm.



Vollplatte | plate

26E 52 020

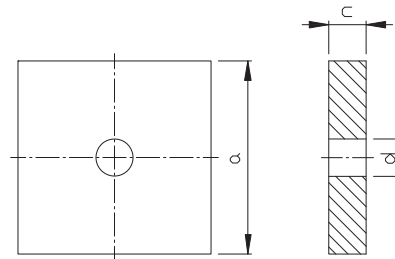

a = □120 mm
c = 20 mm
d = Ø32 mm
Gewicht | weight 2,10 kg
Tragkraft | working load 300 kN
Gurtungsabstand | girder spacing 50 mm
Werkstoff | material S235JR

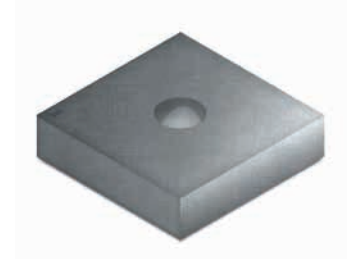

Vollplatte rechteckig | plate rectangular

26E 52 030

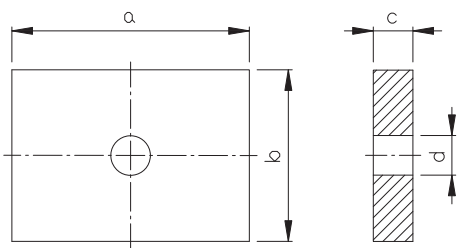

- a = 150 mm
- b = 120 mm
- c = 30 mm
- d = Ø32 mm
- Gewicht | weight 3,99 kg
- Tragkraft | working load 300 kN
- Gurtungsabstand | girder spacing 50 mm
- Werkstoff | material S235JR

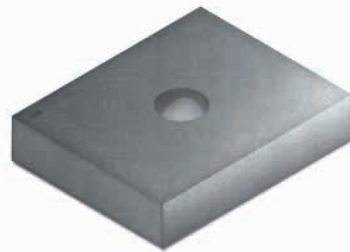

Vollplatte quadratisch | plate square

26E 52 035

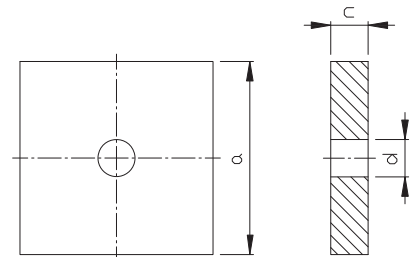

- a = □150 mm
- c = 35 mm
- d = Ø32 mm
- Gewicht | weight 5,70 kg
- Tragkraft | working load 300 kN
- Gurtungsabstand | girder spacing 50 mm
- Werkstoff | material S235JR

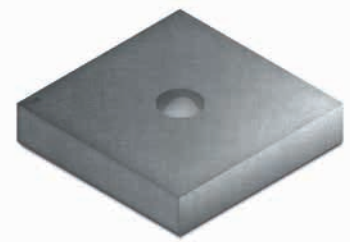

Montageanker | fix anchor

26E 61 120

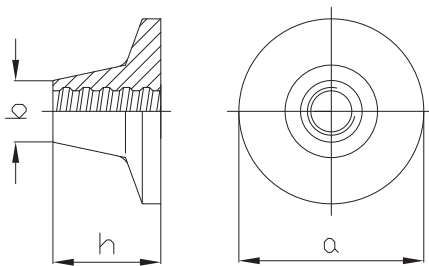

- a = Ø120 mm
- b = Ø40 mm
- h = 70 mm
- Gewicht | weight 1,90 kg
- Betongüte | concrete strength $\geq C 20/25$
 $\geq 25 \text{ MPa}$
- Werkstoff | material EN-GJMW-400-5 / EN-GJS-500-7
EN-GJMW-500-4



Zusatzbewehrung nach statischem Nachweis erforderlich.
Additional reinforcement acc. to analysis.

Beton-/ Felsanker 2-schalig | expansion shell 2-leaf

26E 63 063

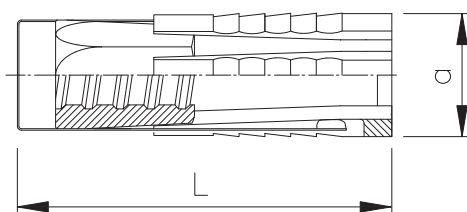

- a = Ø50 mm
- L = 120 mm
- Gewicht | weight 0,58 kg
- Bohrloch | bore hole Ø51-53 mm
- Tragkraft | working load 150 kN
- Werkstoff | material EN-GJMW-400-5 / EN-GJS-500-7



Montage nach Einbauanweisung (siehe Seite 47-48)
Assembling acc. to installation manual (page 47-48)

SAS LokTie - Zugstabsystem | Tie Rod System
ohne Muffe | without coupler

feuerverzinkt
hot-dip galvanized

26E 80 130 FV

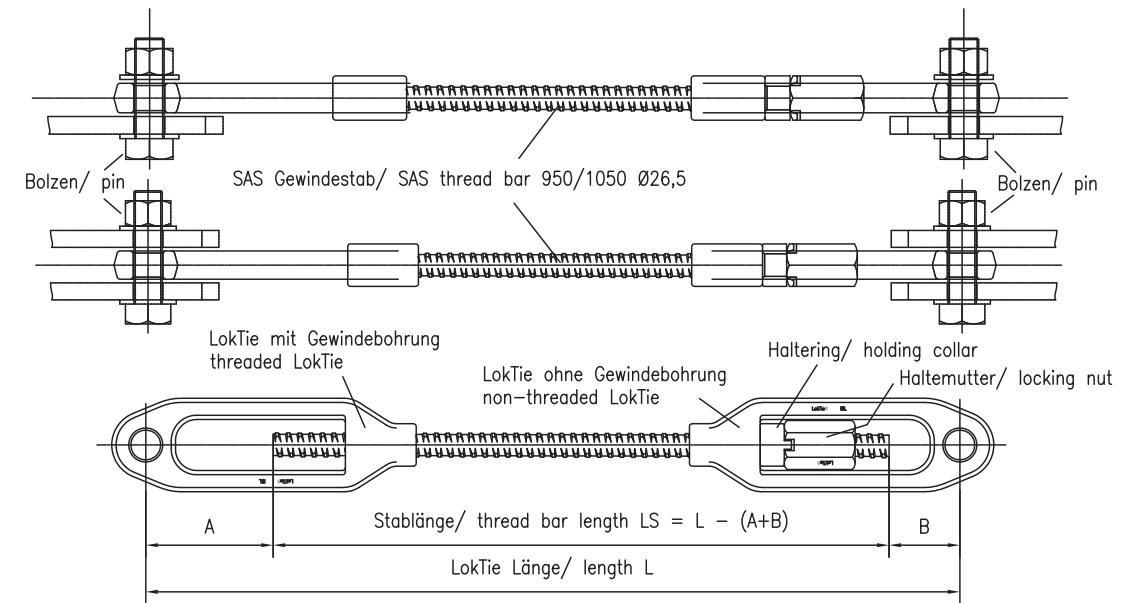

- A = 190 bis 120 mm
- B = 85 bis 60 mm

Tragkraft | working load 290,1 kN

gemäß Zulassung | acc. approval Z - 14.4 - 565

SAS LokTie - Zugstabsystem | Tie Rod System
mit Muffe | with coupler

feuerverzinkt
hot-dip galvanized

26E 30 130 FV

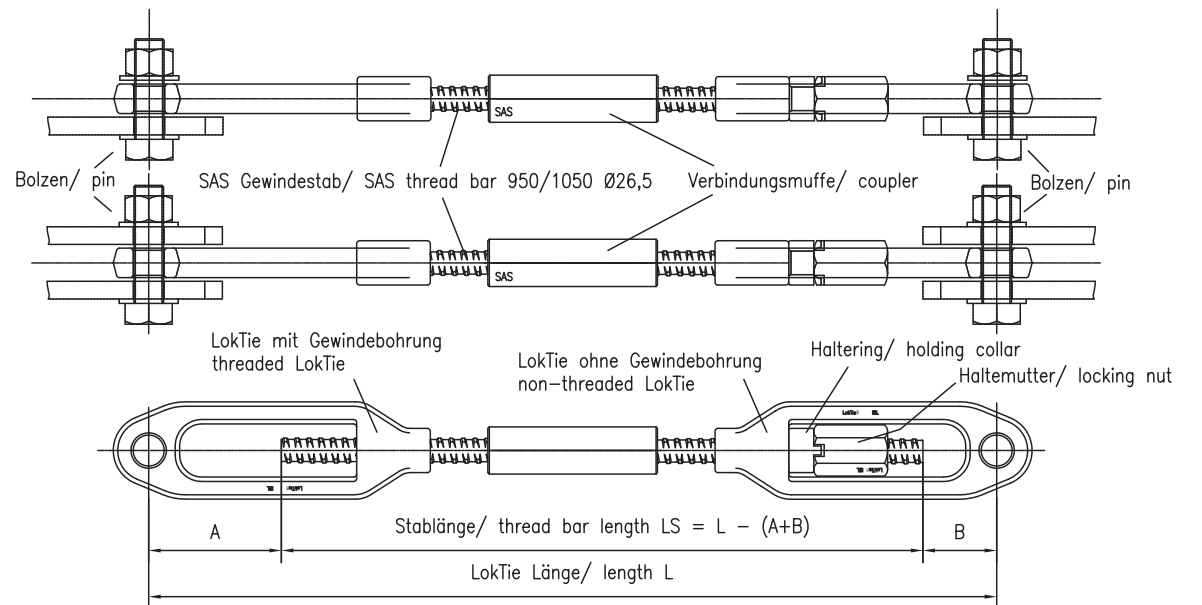

- A = 190 bis 120 mm
- B = 85 bis 60 mm

Tragkraft | working load 274,5 kN

gemäß Zulassung | acc. approval Z - 14.4 - 565

SAS LokTie

LokTie mit Gewinde / ohne Gewinde
LokTie with thread / without thread

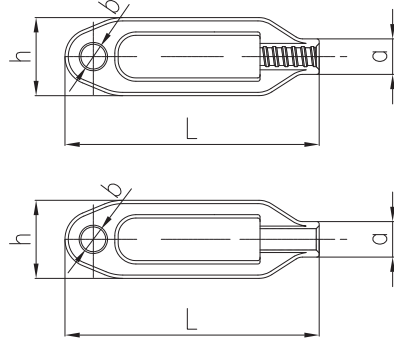

feuerverzinkt
hot-dip galvanized 26E 80 130 FV

a = Ø46 mm
b = Ø31 mm
h = 106 mm
L = 330 mm

Werkstoff | material: G 34 CrMo 4 + QT 1
Gewicht | weight mit Gewinde | with thread = 3,96 kg
ohne Gewinde | without thread = 3,96 kg

Haltermutter | locking nut

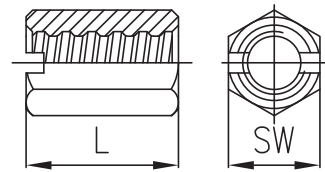

L = 80 mm
SW 46 mm

Werkstoff | material: G 34 CrMo 4 + QT 1
Gewicht | weight 0,70 kg

Haltering | locking ring

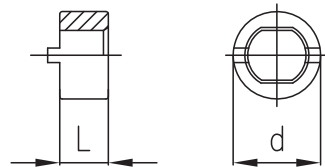

L = 25 mm
d = 46 mm

Werkstoff | material: G 34 CrMo 4 + QT 1
Gewicht | weight 0,09 kg

Verbindungsuffe, rund | coupler, round

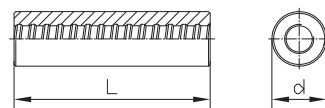

feuerverzinkt
hot-dip galvanized 26E 25 185 FV

L = 185 mm
d = 52 mm

Werkstoff | material: S355J2
Gewicht | weight 2,18 kg

Sechskantmutter | hexagonal nut

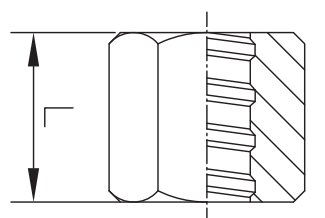

feuerverzinkt
hot-dip galvanized 26E 22 030 FV

L = 30 mm
SW 46 mm

Werkstoff | material: S355J2C+C
Gewicht | weight 0,27 kg

Verwendung nur zur Lagesicherung | use only for fixing position

Keilklemme leichte Ausführung | cam clamp light version



verzinkt oder lackiert |
galvanized or painted 10F 11 008

90 x 60 mm

Gewicht | weight 0,26 kg

Für Rundeisen bis Ø8 mm | For round bars up to Ø8 mm

Keilklemme aus Guß | cam clamp cast iron



verzinkt oder lackiert |
galvanized or painted 10F 11 010

110 x 40 mm

Gewicht | weight 0,43 kg

Keil geschmiedet, vergütet | Wedge forged, tempered.
Für Rundeisen Ø5 - 10 mm | For round bars up to Ø5 - 10 mm

Keilklemme aus Guß | cam clamp cast iron



verzinkt oder lackiert |
galvanized or painted 10F 11 013

110 x 40 mm

Gewicht | weight 0,46 kg

Keil geschmiedet, vergütet | Wedge forged, tempered.
Für Rundeisen Ø8 - 13 mm | For round bars up to Ø8 - 13 mm

Federklemme verstärkt | spring clamp strengthened



verzinkt oder lackiert |
galvanized or painted 10F 12 200

110 x 75 mm

Gewicht | weight 0,42 kg

Für Rundeisen Ø5 - 10 mm | For round bars up to Ø5 - 10 mm
Bewährtes Feder-Exzenter-System | reliable spring-excentric-system

Spindelspanner für Keilklemme | *spindle-spanner for cam clamp*

verzinkt oder lackiert |
galvanized or painted

10F 16 012



Gewicht | *weight* 1,42 kg
Für Rundeisen bis Ø 12 mm | *For round bars up to Ø 12 mm*

Hebelspanner für Federklemme | *level-spanner for spring clamp*

verzinkt oder lackiert |
galvanized or painted

10F 17 100



Gewicht | *weight* 2,70 kg
Tragkraft | *working load* 25 kN
Für Rundeisen bis Ø 12 mm | *For round bars up to Ø 12 mm*

Spindelspanner für Federklemme | *spindle-spanner for spring clamp*

verzinkt oder lackiert |
galvanized or painted

10F 18 100



Gewicht | *weight* 1,20 kg
Für Rundeisen bis Ø 12 mm | *For round bars up to Ø 12 mm*

Spannstabausdreher | *tie rod remover*

verzinkt | *galvanized*

15F 71 001



Gewicht | *weight* 0,40 kg
Für SAS Schalungsanker Ø 15 Typ FA / FC / FS
For SAS Tie Rods Ø 15 Type FA / FC / FS

Spannstabausdreher | *tie rod remover*

verzinkt | *galvanized*

10F 71 002 G



Gewicht | *weight* 1,90 kg
Für SAS Schalungsanker Ø 15 + Ø 20 Typ FA / FC
For SAS Tie Rods Ø 15 + Ø 20 Type FA / FC

Konenschlüssel | *cone wrench*

verzinkt | *galvanized* 15F 16 100



SW = 27 mm
Gewicht | *weight* 1,10 kg
Für Stahl-Kunststoffkonus Typ MKK | *For steel-plastic cone type MKK*

4-Kant-Konenschlüssel | *square cone wrench*

verzinkt | *galvanized* 15F 16 110



Gewicht | *weight* 1,60 kg
□ 13 mm für Vorlaufkonus Typ 30 | *for cone type 30*
□ 18 mm für Vorlaufkonus Typ 30 / M24 | *for cone type 30 / M24*

Konenschlüssel Typ 40/M36 | *cone wrench type 40/M36*

verzinkt | *galvanized* 26E 15 041



Gewicht | *weight* 1,96 kg
Für Stahlkonus Typ 40/M36 (26E 15 040) | *for cone type 40/M36 (26E 15 040)*

V-Halter | *V-holder*

verzinkt | *galvanized* 15F 66 300
20F 66 300
26E 66 300

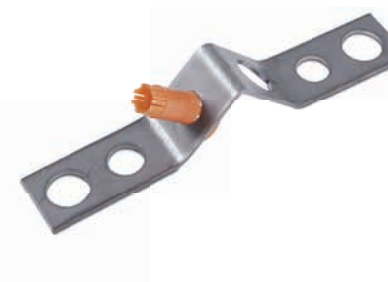

Gewicht | *weight*:
Ø 15 0,42 kg
Ø 20 0,43 kg
Ø 26,5 0,44 kg
Halterung für Schlaufenanker 45° | *For fixing loop anchor 45°*

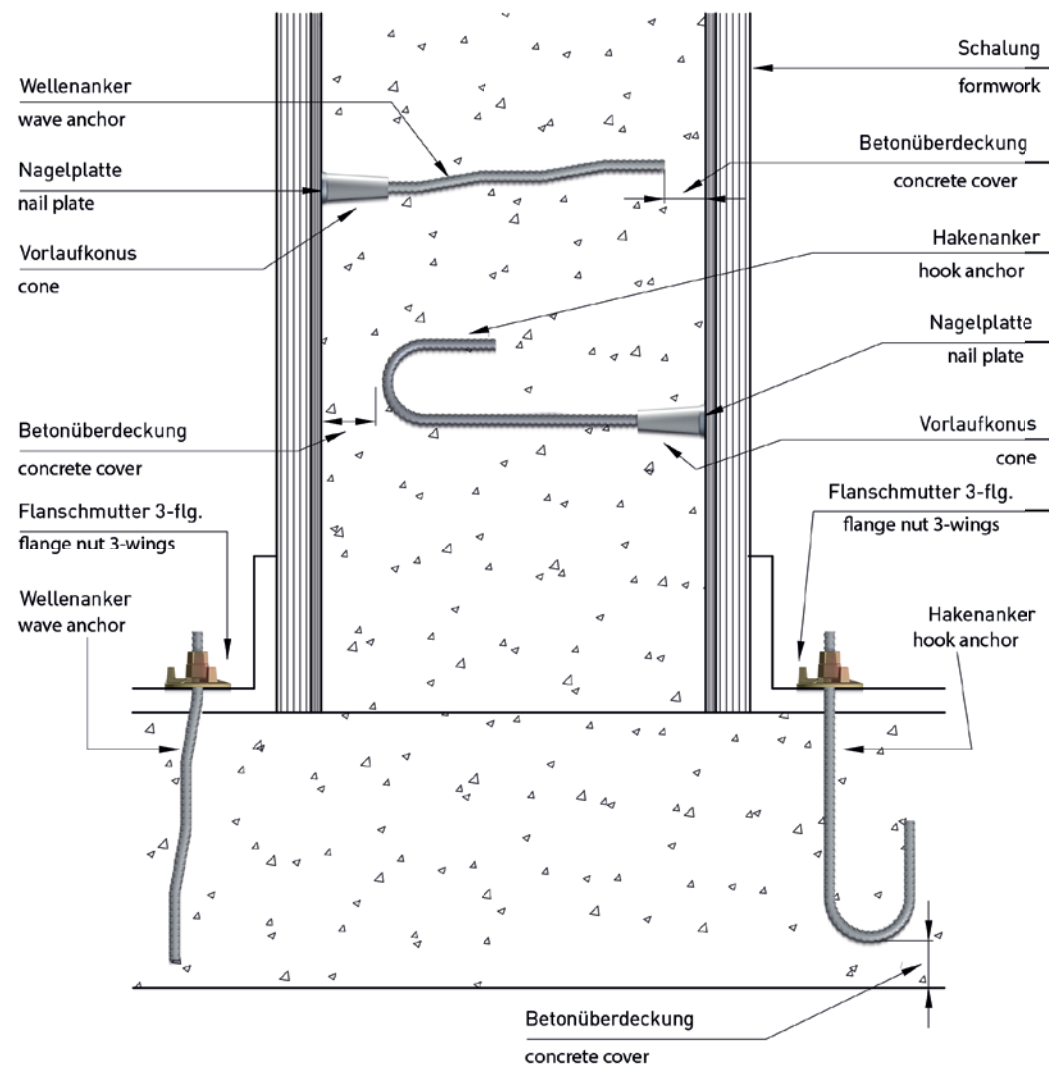

- Wellenanker | wave anchor 15FA 66 550 W
- Hakenanker | hook anchor 15FA 64 250 H
- Hakenanker | hook anchor 15FA 64 450 H
- Vorlaufkonus Typ 30 | cone type 30 15F 17 030
- Nagelplatte | nail plate 15F 17 030 N
- Flanschmutter 3-flg. | flange nut 3-wings 15F 31...G

Der Einbau der Schalungsankersysteme muss durch qualifiziertes Personal erfolgen!
 The installation of the system has to be carried out by instructed staff!

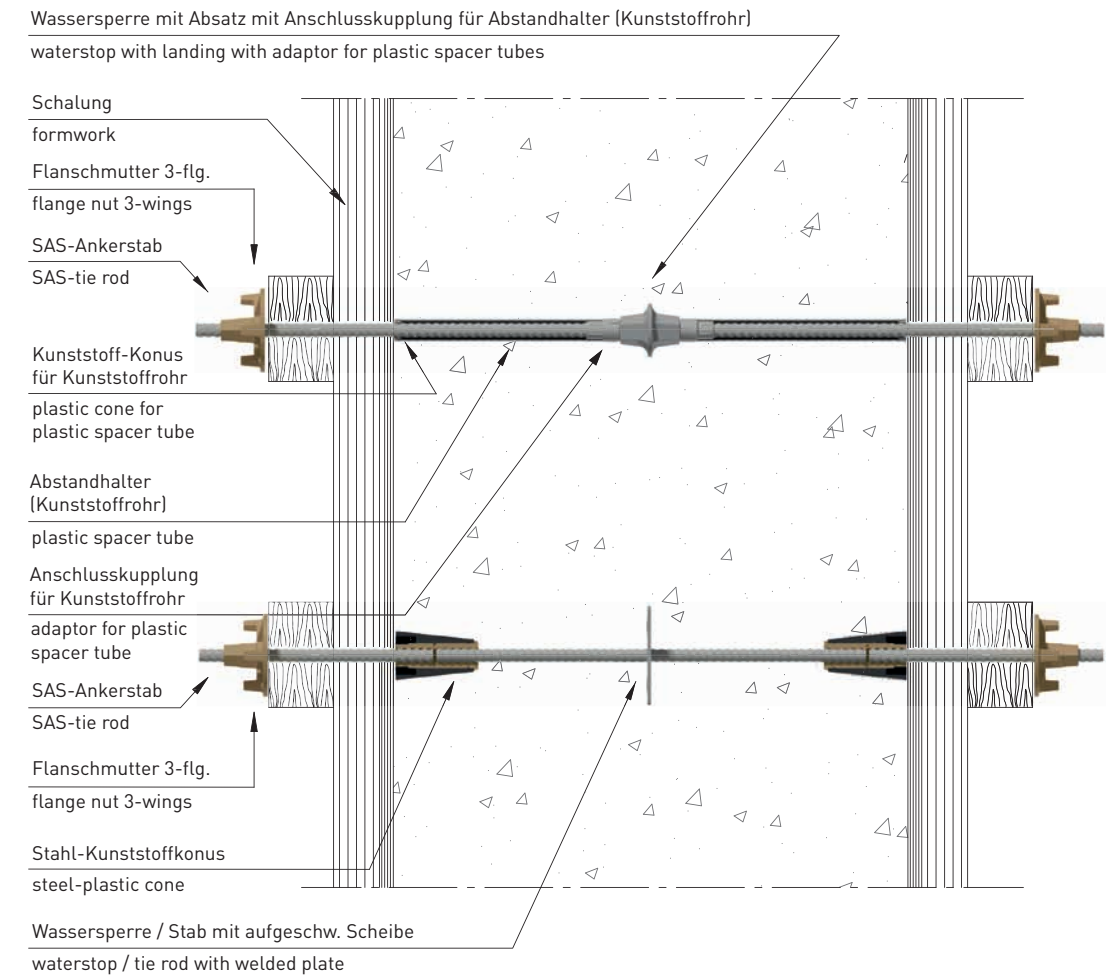

- Wassersperre mit Absatz | waterstop with landing 15F 44 110 S
- Anschlusskupplung für Kunststoffrohr | adapter for plastic spacer tube 15F 44 110 A
- Wassersperre / Stab mit aufgeschweißter Scheibe | waterstop / tie rod with welded plate 15FS 43 000
- Stahl-Kunststoffkonus Typ MKK | steel-plastic cone type MKK 15F 14 100
- Flanschmutter 3-flg. | flange nut 3-wings 15F 31...G

Die Ankerstäbe (nicht Wassersperre / Stab mit aufgeschweißter Scheibe) und die Stahl-Kunststoffkonus müssen wieder ausgebaut werden.
 Nach dem Ausbau müssen die Löcher mit Betonstopfen zugeklebt oder mit Mörtel verschlossen werden.
 The tie rods (except waterstop / tie rod with welded plate) and the steel plastic cones have to be removed.
 After removing the remaining holes have to be closed by concrete plugs or filling with mortar.

Der Einbau der Schalungsankersysteme muss durch qualifiziertes Personal erfolgen!
 The installation of the system has to be carried out by instructed staff!

ejemplo 3

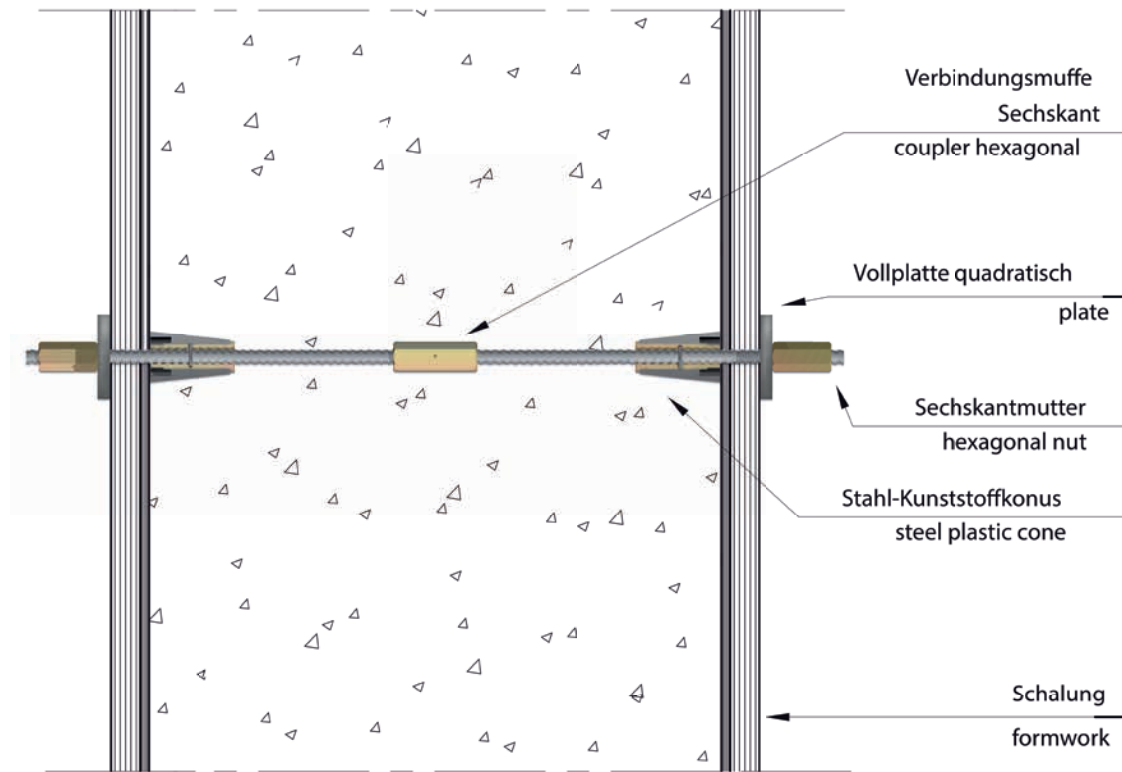

- Sechskantmutter | hexagonal nut 26E 22 080
- Vollplatte, quadratisch | plate 26E 52 020
- Verbindungsuffe Sechskant | coupler hexagonal 26E 28 150
- Stahl-Kunststoffkonus Typ MKK | steel-plastic cone type MKK 26E 14 135

ejemplo 4

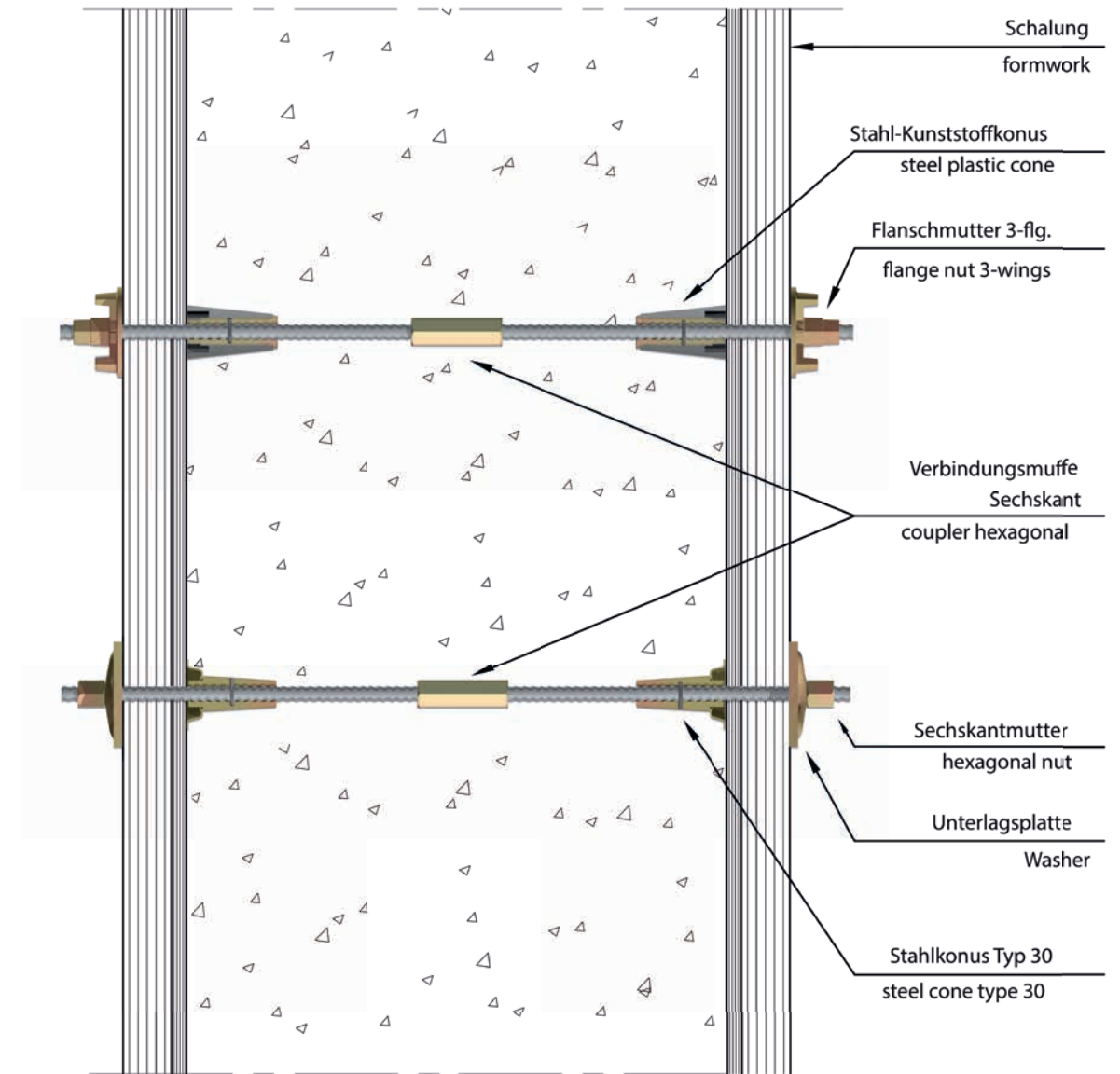

- Stahl-Kunststoffkonus Typ MKK | steel-plastic cone type MKK 15F 14 100
- Flanschmutter 3-flg. | flange nut 3-wings 15F 31...G
- Verbindungsuffe Sechskant | coupler hexagonal 15F 28 100
- Sechskantmutter, Vollast | hexagonal nut 15F 22 050
- Unterlagsplatte geprägt | washer stamped 15F 52 010 G
- Stahlkonus Typ 30 | steel cone type 30 15F 12 030

Der Einbau der Schalungsankersysteme muss durch qualifiziertes Personal erfolgen!
 The installation of the system has to be carried out by instructed staff!

Der Einbau der Schalungsankersysteme muss durch qualifiziertes Personal erfolgen!
 The installation of the system has to be carried out by instructed staff!

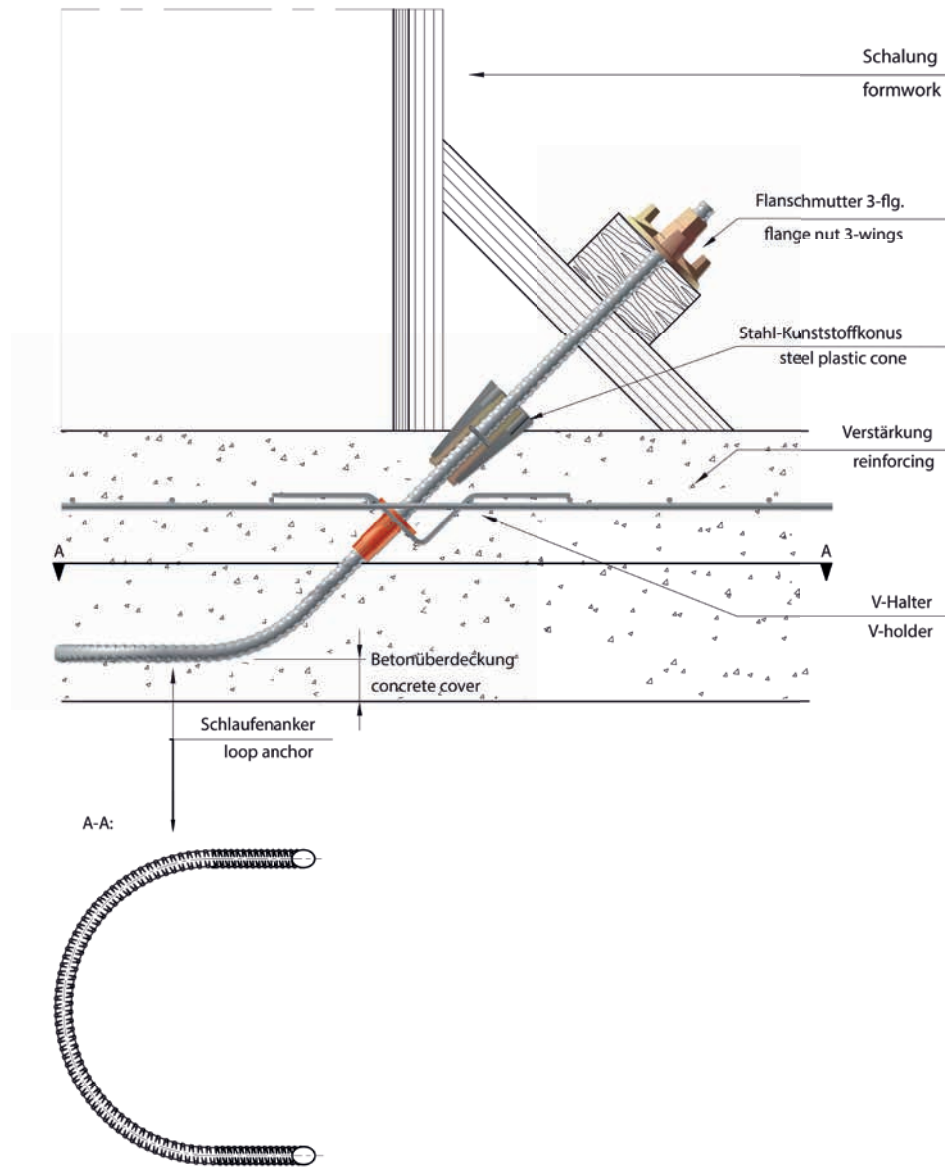

- Schlaufenanker | loop anchor 15FA 65 550 S
- Stahl-Kunststoffkonus Typ MKK | steel-plastic cone type MKK 15F 14 100
- Flanschmutter 3-flg. | flange nut 3-wings 15F 31...G
- V-Halter | v-holder 15F 66 300

Der Schlaufenanker muss so eingebaut werden, dass der Stahl-Kunststoffkonus aus dem Beton heraus steht.
 Nach dem Entfernen der Schalung kann der Stahl-Kunststoffkonus herausgeschraubt werden.
*The loop anchor has to be placed, that the steel-plastic cone looks out of the concrete.
 After removing of the formwork the steel-plastic cone can be screwed off.*

Der Einbau der Schalungsankersysteme muss durch qualifiziertes Personal erfolgen!
The installation of the system has to be carried out by instructed staff!

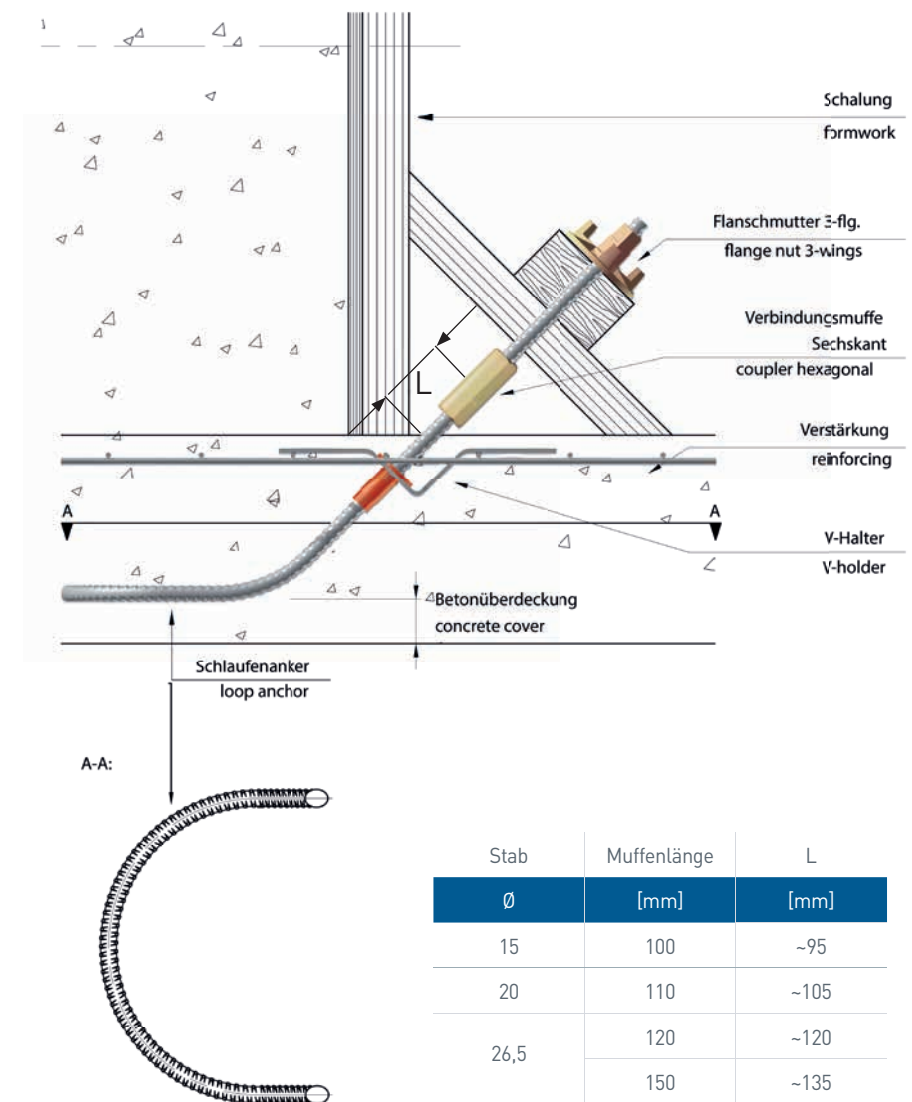

- Schlaufenanker | loop anchor 15FA 65 550 S
- Verbindungs-muffe, sechskant | coupler, hexagonal 15F 28 100
- Verbindungs-muffe, sechskant | coupler, hexagonal 15F 28 100 G
- Flanschmutter 3-flg. | flange nut 3-wings 15F 31...G
- V-Halter | v-holder 15F 66 300

Der Schlaufenanker muss so eingebaut werden, dass das Stabende gemäß den Angaben aus der Tabelle aus dem Beton heraus steht.
 Nach dem Betonieren kann die Verbindungs-muffe (sechskant) zur Verlängerung aufgeschraubt werden.
*The loop anchor has to be placed, that the end of the tie rod looks out of the concrete as indicated in the table.
 After concreting the coupler (hexagonal) can be screwed on the tie rod for lengthening.*

Der Einbau der Schalungsankersysteme muss durch qualifiziertes Personal erfolgen!
The installation of the system has to be carried out by instructed staff!

ejemplo 7

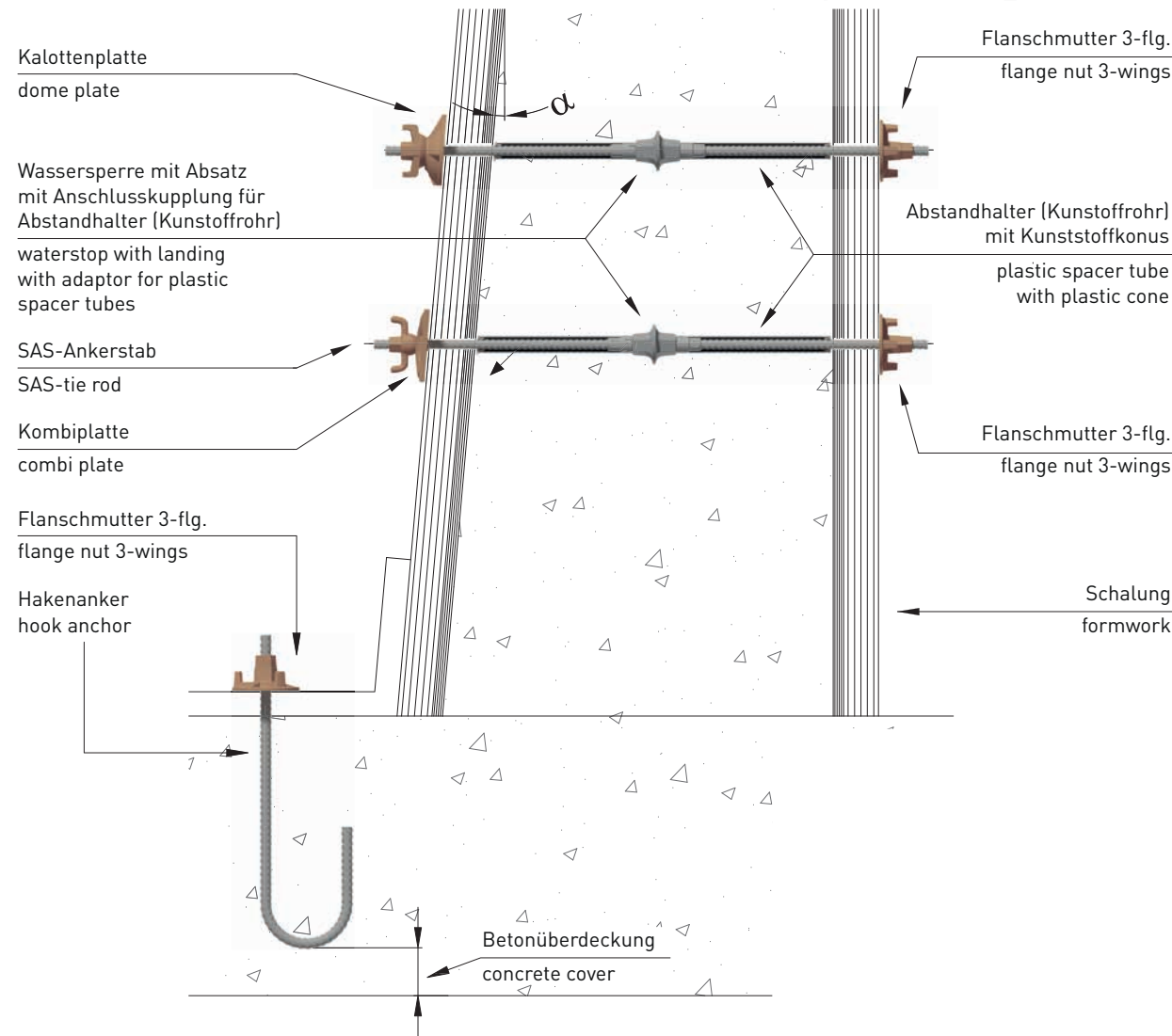

Mögliche Neigung α der Schalung bei Verwendung folgenden Zubehörs:
Possible inclination α of formwork using the following accessories:

Kombiplatte Combi Plate	15F 72 010 G	4°	15F 74 010 G	5°	15F 75 010 G	5°
Kalottenplatte Dome Plate	15F 72 120 G	8°	15F 73 130 G	9°	20F 73 130 G	5°

- Hakenanker | hook anchor 15FA 64 250 H
- Hakenanker | hook anchor 15FA 64 450 H
- Wassersperre mit Absatz | waterstop with landing 15F 44 110 S
- Anschlusskupplung | adaptor 15F 44 110 A
- Kombiplatte | combi plate 15F 72 010 G
- Kalottenplatte | dome plate 15F 72 120 G
- Flanschmutter 3-flg. | flange nut 3-wings 15F 31 ...G

Die Ankerstäbe müssen wieder ausgebaut werden.
Nach dem Ausbau müssen die Löcher mit Betonstopfen zugeklebt oder mit Mörtel verschlossen werden.
The tie rods have to be removed. After removing, the remaining holes have to be closed by concrete plugs or filling with mortar.

Der Einbau der Schalungsankersysteme muss durch qualifiziertes Personal erfolgen!
The installation of the system has to be carried out by instructed staff!

ejemplo 8

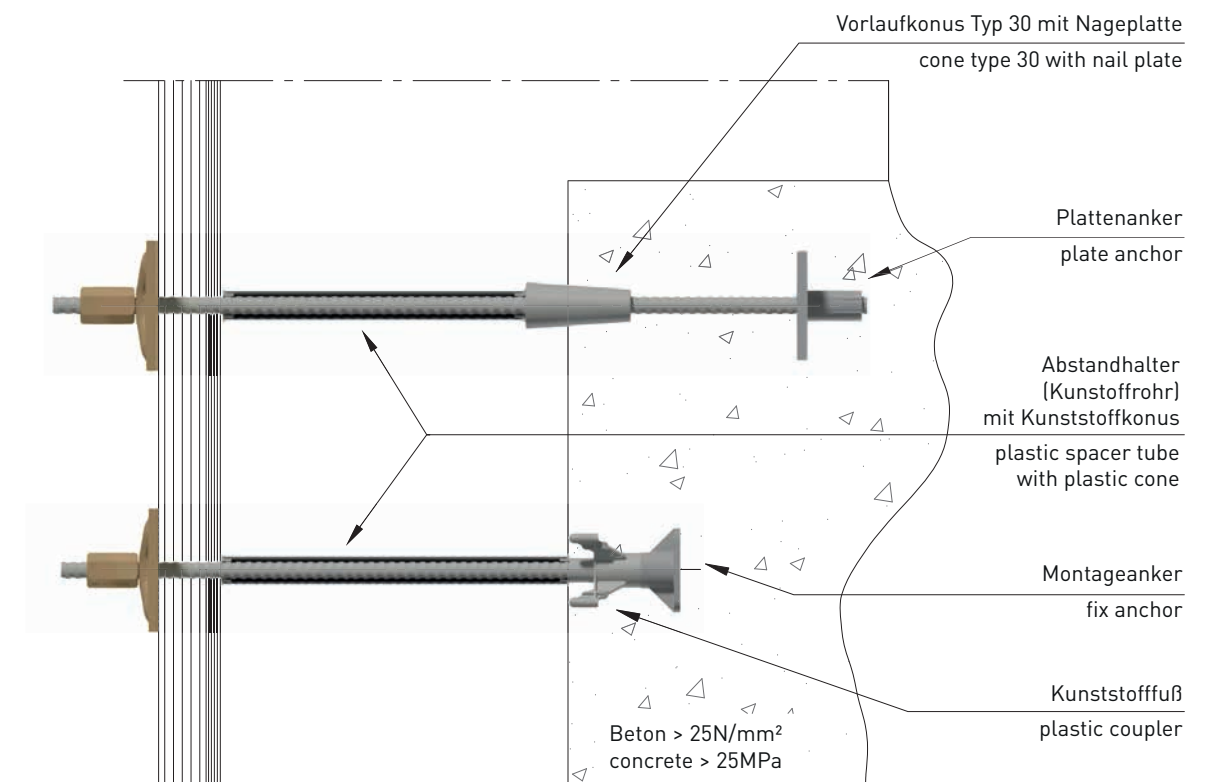

- Plattenanker | plate anchor 15FS 63 160
- Vorlaufkonus Typ 30 | cone type 30 15F 17 030
- Nagelplatte für Vorlaufkonus Typ 30 | nail plate for cone type 30 15F 17 030 N
- Montageanker | fix anchor 15F 61 070
- Montageanker | fix anchor 15F 61 055
- Kunststofffuß für Montageanker | plastic coupler 15F 62 055

Zusatzbewehrung nach statischem Nachweis erforderlich. | Additional reinforcement acc. to analysis.

Der Einbau der Schalungsankersysteme muss durch qualifiziertes Personal erfolgen!
The installation of the system has to be carried out by instructed staff!

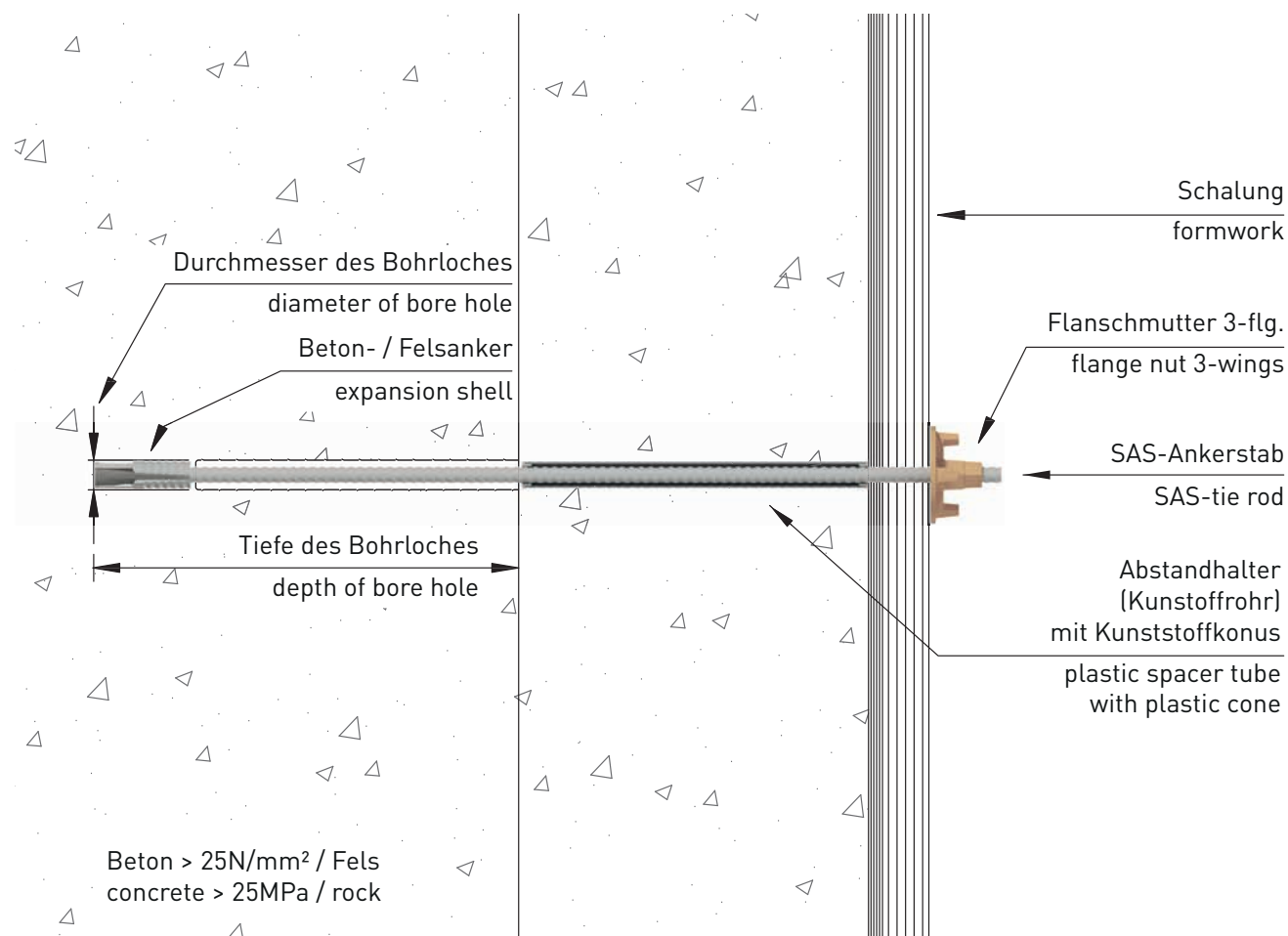

- Beton-/Felsanker Ø15 mm | expansion shell Ø15 mm 15F 63 034
- Beton-/Felsanker Ø15 mm | expansion shell Ø15 mm 15F 63 037
- Beton-/Felsanker Ø20 mm | expansion shell Ø20 mm 20F 63 053
- Beton-/Felsanker Ø26,5 mm | expansion shell Ø26,5 mm 26E 63 063

Orientierungswerte für Beton- und Felsanker
Orientation values for Expansion Shells

	15F 63 034	15F 63 037	20F 63 053	26E 63 063
Bohrloch- bore hole - Ø [mm] *	33 - 35	35 - 37	40 - 42	51 - 53
Bohrlochtiefe depth of bore hole t [cm] *	23	32	35	42
Effektive Verankerungstiefe effective anchorage depth h _{eff} [cm] *	20	26	32	37
Mindest-Bohrlochabstand min. distance to next bore hole 3 x t [cm] *	60	78	96	111
Mindest-Randabstand min. distance to edge 1,5 x t [cm] *	30	39	48	56

*Angegebene Werte stellen reine Orientierungshilfen dar. Die tatsächliche aufnehmbare Traglast ist auf Grundlage der Vorgaben der EN 1992-4 und den örtlichen Gegebenheiten zu ermitteln und durch Probelastungen nachzuweisen.
Specified values are just orientation values. The actual load bearing capacity shall be determined on the basis of the requirements of EN 1992-4 and the local conditions and verified by means of load capacity tests on site.

Anker auf Ankerstabende aufschrauben. Der farbige Plastikring muss dabei auf dem Betonanker bleiben. Stab ganz durch den Konus des Spreizdübels durchschrauben, 1-2 Gewindegänge sollten am oberen Ende überstehen.

Stab mit Anker ins Bohrloch einschieben. Der Plastikring muss sich dabei am Bohrlochrand abstreifen (falls nicht, muss der Ring mit der Hand abgestriffen werden).

ACHTUNG:

- Einbindetiefe, Rand- und Achsabstand sind ausreichend zu wählen.
- Vor der endgültigen Belastung sind Belastungsprüfungen vor Ort vorzunehmen. Dabei ist auf ungünstigste Bedingungen zu achten, wie größtmögliches Bohrloch, schlechtestmögliche Beton- bzw. Felsqualität.
- Der Anker ist mittels Hohlkolbenpresse zu „ziehen“ bis er versagt bzw. die angegebene Prüflast in der beigefügten Tabelle „Prüflasten für Beton u. Felsanker“ erreicht (1,5-fache Gebrauchslast). Versagt der Anker vorher, können die Parameter Bohrlochtiefe, Bohrlochdurchmesser, Achs- und Randabstand variiert werden und ein neuer Zugversuch erfolgen. Die zulässige Arbeitslast wird aus der Versagenslast mit einem Sicherheitsfaktor von 1,5 ermittelt.

Beispiel:

Versagenslast vor Ort: 100kN
Max. zulässige charakteristische Arbeitslast: 100/1,5 = 67kN

- Beton- bzw. Felsgüte und Bohrlochdurchmesser sind die ausschlaggebenden Faktoren für die Tragkraft des Ankers. Die Wahl des kleineren empfohlenen Bohrlochdurchmessers kann zu erheblich günstigeren Traglasten führen.
- **Zugversuch mit größter Sorgfalt durchführen** – Kräfte können bei Stabbruch überraschend und schlagartig freierwerden. **Lebensgefahr!**

Für Spreizdübel sind keine Zulassungen vorgeschrieben und deshalb auch nicht verfügbar.

Screw expansion shell on the bar (tie rod) and take care that the bar is screwed through the cone of the expansion shell. 1-2 pitches of thread bar should be extend out of the cone. The coloured plastic ring must remain on the expansion shell.

Put the assembled anchor into the well prepared borehole. The coloured plastic ring must be removed through the edge of the borehole; if not it must be removed by hand.

ATTENTION:

- Embedment depth, edge and center distance shall be chosen sufficiently.
- Before putting a full load on the anchor a pull out test under worst conditions on site shall be carried out (biggest possible borehole and worst quality of concrete or rock/soil).
- The pull out test has to be done with a centre-hole jack up to slippage of the anchor or up to the testing load according to table "Testing loads for expansion shells". (1.5 times working load) If the anchor is pulled out before, vary the parameters borehole depth, borehole diameter, axis and edge distance and conduct a new pull out test. The permitted working load is determined from the failure load with a safety factor of 1.5.

Example: Reached failure load on site: 100 kN
Max. characteristic working load: 100 / 1.5 = 67 kN

- In any case please be aware that the concrete quality or rock or soil as well as size of borehole will affect the anchor behaviour. The choice of the smaller recommended borehole diameter can lead to a significant higher load capacity.
- The pull out tests should be conducted very carefully using experienced and skilled people only.
- There is high danger due to uncontrolled energy/power if the anchor slips out or break. Danger of life!

There is no special approval for expansion shells available as it is not required.

Zusatzbewehrung nach statischem Nachweis erforderlich. | Additional reinforcement acc. to analysis.

Der Einbau der Schalungsankersysteme muss durch qualifiziertes Personal erfolgen!
The installation of the system has to be carried out by instructed staff!

Der Einbau der Schalungsankersysteme muss durch qualifiziertes Personal erfolgen!
The installation of the system has to be carried out by instructed staff!

Probezug für Beton- und Felsanker | Instruction for Pull-out-test of expansion shell

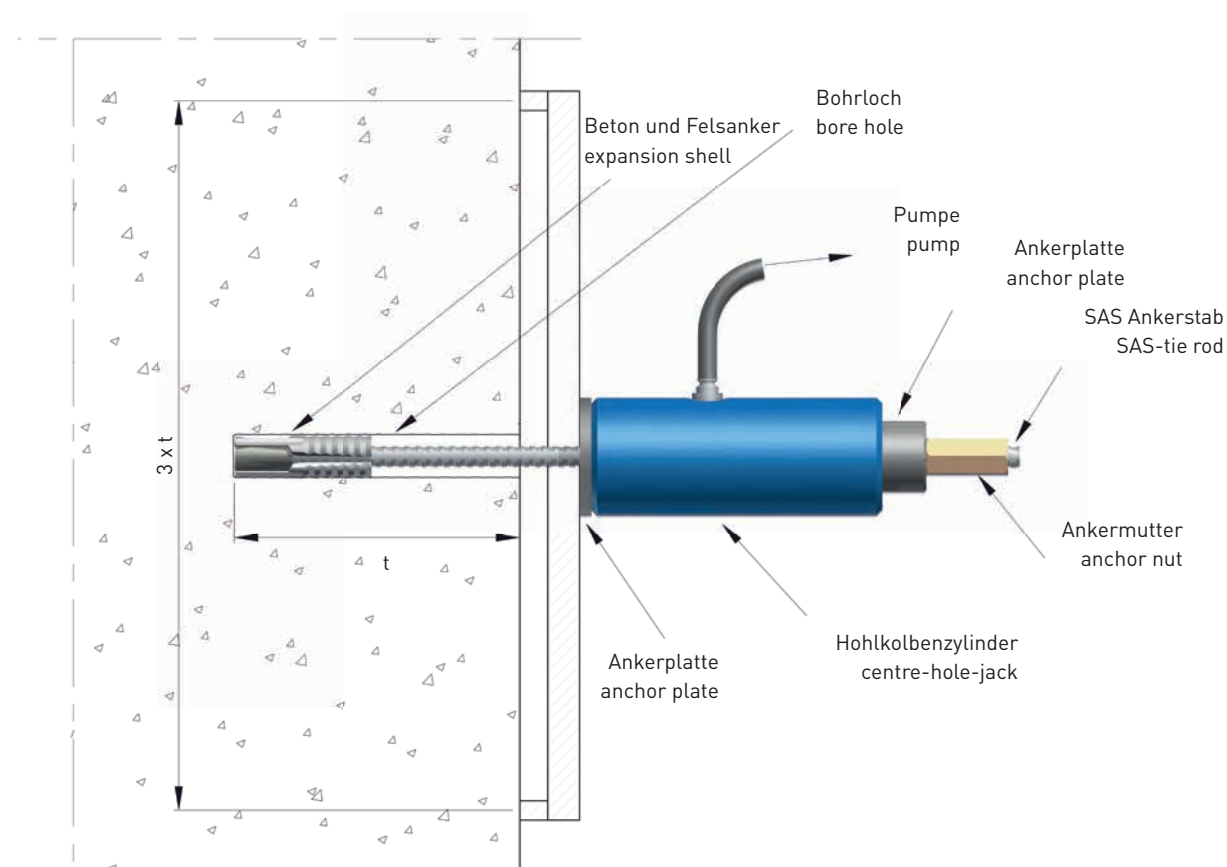

Prüflasten für Beton- und Felsanker | Testing loads for Expansion Shell

Beton- und Felsanker Expansion Shell	Arbeitslast Working load [kN]	Prüfkraft F_p Testing load F_p [kN]	Hohlkolbenzylinder / centre hole jack
15F 63 034	60	90	
15F 63 037	90	135	Kraft force ≥ 200 kN • Hub lift ≥ 150 mm • Enerpac RCH-206
20F 63 053	120	180	
26E 63 063	150	225	Kraft force ≥ 300 kN • Hub lift ≥ 150 mm • Enerpac RCH-206

Die Prüflasten sind Empfehlungen und keine Garantie für die tatsächliche Tragfähigkeiten des Beton- / Felsankers.
The testing loads are a recommendation and not a guarantee of the real load capacity of Expansion Shells.



SAS Gewindestäbe | SAS thread bar

Streckgrenze / Zugfestigkeit | yield stress / ultimate stress
Anwendungsbereiche | areas of application

Nenn- \varnothing | Strecklast | Bruchlast | Fläche | Gewicht | Dehnung
nom.- \varnothing | yield load | ultimate load | cross section area | weight | elongation
[mm] | [kN] | [kN] | [mm²] | [m/to] | [kg/m] | A_{gt} [%] | A₁₀ [%]

SAS 500 / 550 – grade 75

 Bewehrungstechnik | reinforcing systems

12	57	62	113	1123,6	0,89	6	10
14	77	85	154	826,4	1,21		
16	100	110	201	632,9	1,58		
20	160	175	314	404,9	2,47		
25	245	270	491	259,7	3,85		
28	310	340	616	207,0	4,83		
32	405	440	804	158,5	6,31		
36	510	560	1020	125,2	7,99		
40	630	690	1260	101,3	9,87		
43	726	799	1452	87,7	11,40		

 Geotechnik | geotechnical systems

50	980	1080	1960	64,9	15,40		
----	-----	------	------	------	-------	--	--

SAS 555 / 700 – grade 80

57,5	1441	1818	2597	49,1	20,38	5	---
------	------	------	------	------	-------	---	-----

SAS 555 / 700 – grade 80

63,5	1760	2215	3167	40,2	24,86	5	---
------	------	------	------	------	-------	---	-----

SAS 500 / 550 – grade 75

75	2209	2430	4418	28,8	34,68	5	---
----	------	------	------	------	-------	---	-----

Alternativ SAS 550 / 620 erhältlich | alternative SAS 550 / 620 available

SAS 450 / 700 – grade 60

 Bergbau | mining

16	93	145	207	617,3	1,62		[A ₅] 15
25	220	345	491	259,7	3,85		[A ₅] 20

SAS 650 / 800 – grade 90

 Bergbau | mining

22	247	304	380	335,6	2,98	[A ₅] 18
25	319	393	491	259,7	3,85	
28	400	493	616	207,0	4,83	
30	460	565	707	180,2	5,55	

SAS 670 / 800 – grade 97

 Geotechnik | geotechnical systems

18	170	204	254	500,0	2,00	5	10	
22	255	304	380	335,6	2,98			
25	329	393	491	259,7	3,85			
28	413	493	616	207,0	4,83			
30	474	565	707	180,2	5,55			
35	645	770	962	132,5	7,55			
43	973	1162	1452	87,7	11,40			
50	1315	1570	1963	64,9	15,40			
57,5	1740	2077	2597	49,1	20,38			---
63,5	2122	2534	3167	40,2	24,86			---

 Hochfeste Bewehrung | high-strength reinforcement

75	2960	3535	4418	28,8	34,68	---	---
----	------	------	------	------	-------	-----	-----

SAS 950 / 1050 – grade 150

 Spanntechnik | post-tensioning systems

18	230	255	241	510,2	1,96	5	7
26,5	525	580	551	223,2	4,48		
32	760	845	804	153,1	6,53		
36	960	1070	1020	120,9	8,27		
40	1190	1320	1257	97,9	10,21		
47	1650	1820	1735	70,9	14,10		

 Geotechnik | geotechnical systems

SAS 835 / 1035 – grade 150

 Geotechnik | geotechnical systems

57	2155	2671	2581	47,7	20,95	4	---
65	2780	3447	3331	36,9	27,10		---
75	3690	4572	4418	27,9	35,90		---

SAS 900 / 1100 FA – grade 160 FA

 Schalungstechnik | formwork ties

15	159	195	177	694,4	1,44	3	7
20	283	345	314	390,6	2,56		
26,5	495	606	551	223,2	4,48	2	

SAS 900 / 1050 FC – grade 150 FC

 Schalungstechnik | formwork ties

15	159	186	177	694,4	1,44	3	7
20	283	330	314	390,6	2,56		

SAS 950 / 1050 E – grade 150

26,5	525	580	551	223,2	4,48	5	7
------	-----	-----	-----	-------	------	---	---

SAS 750 / 875 FS – kaltgerollt | cold rolled – grade 120 FS

 Schalungstechnik | formwork ties

12,5	90	120	132,5	961,5	1,04	2	5,5
15	142	165	189	675,7	1,48		
20	245	285	326	390,6	2,56		

Zubehör für alle Abmessungen und Anwendungen lieferbar | accessories for all dimensions and applications available